

DENON *PROFESSIONAL*

NETWORKED CD PLAYER

DN-C640

OPERATING INSTRUCTIONS

IMPORTANT TO SAFETY

WARNING:

To reduce the risk of fire and electric shock, this apparatus should not be exposed to rain or moisture and objects filled with liquids, such as vases, should not be placed on this apparatus

CAUTION

1. Handle the power supply cord carefully

Do not damage or deform the power supply cord. If it is damaged or deformed, it may cause electric shock or malfunction when used. When removing from wall outlet, be sure to remove by holding the plug attachment and not by pulling the cord.

2. Do not open the rear cover

In order to prevent electric shock, do not open the top cover.

If problems occur, contact your DENON DEALER.

3. Do not place anything inside

Do not place metal objects or spill liquid inside the system.

Electric shock or malfunction may result.

Please, record and retain the Model name and serial number of your set shown on the rating label.

Model No. DN-C640

Serial No. _____



CAUTION
RISK OF ELECTRIC SHOCK
DO NOT OPEN



CAUTION:

TO REDUCE THE RISK OF ELECTRIC SHOCK, DO NOT REMOVE COVER (OR BACK). NO USER-SERVICEABLE PARTS INSIDE. REFER SERVICING TO QUALIFIED SERVICE PERSONNEL.



The lightning flash with arrowhead symbol, within an equilateral triangle, is intended to alert the user to the presence of uninsulated "dangerous voltage" within the product's enclosure that may be of sufficient magnitude to constitute a risk of electric shock to persons.



The exclamation point within an equilateral triangle is intended to alert the user to the presence of important operating and maintenance (servicing) instructions in the literature accompanying the appliance.

NOTE:

This Networked CD Player uses the semiconductor laser. To allow you to enjoy music at a stable operation, it is recommended to use this in a room of 5°C (41°F) ~ 35°C (95°F).

LABELS (for U.S.A. model only)

CERTIFICATION

THIS PRODUCT COMPLIES WITH DHHS RULES 21 CFR SUBCHAPTER J APPLICABLE AT DATE OF MANUFACTURE.

CAUTION:

USE OF CONTROLS OR ADJUSTMENTS OR REFORMATION OF PROCEDURES OTHER THAN THOSE SPECIFIED HEREIN MAY RESULT IN HAZARDOUS RADIATION EXPOSURE.

THE COMPACT DISC PLAYER SHOULD NOT BE ADJUSTED OR REPAIRED BY ANYONE EXCEPT PROPERLY QUALIFIED SERVICE PERSONNEL.

FCC INFORMATION (For US customers)

1. PRODUCT

This product complies with Part 15 of the FCC Rules. Operation is subject to the following two conditions: (1) this product may not cause harmful interference, and (2) this product must accept any interference received, including interference that may cause undesired operation.

2. IMPORTANT NOTICE:

DO NOT MODIFY THIS PRODUCT

This product, when installed as indicated in the instructions contained in this manual, meets FCC requirements. Modification not expressly approved by DENON may void your authority, granted by the FCC, to use the product.

3. NOTE

This product has been tested and found to comply with the limits for a Class B digital device, pursuant to Part 15 of the FCC Rules. These limits are designed to provide reasonable protection against harmful interference in a residential installation.

This product generates, uses and can radiate radio frequency energy and, if not installed and used in accordance with the instructions, may cause harmful interference to radio communications. However, there is no guarantee that interference will not occur in a particular installation. If this product does cause harmful interference to radio or television reception, which can be determined by turning the product OFF and ON, the user is encouraged to try to correct the interference by one or more of the following measures:

- Reorient or relocate the receiving antenna.
- Increase the separation between the equipment and receiver.
- Connect the product into an outlet on a circuit different from that to which the receiver is connected.
- Consult the local retailer authorized to distribute this type of product or an experienced radio/TV technician for help.

This Class B apparatus complies with Canadian ICES-003. Cet appareil numérique de la classe B est conforme à la norme NMB-003 du Canada.

IMPORTANT SAFETY INSTRUCTIONS

READ BEFORE OPERATING EQUIPMENT

This product was designed and manufactured to meet strict quality and safety standards. There are, however, some installation and operation precautions which you should be particularly aware of.

1. Read these instructions.
2. Keep these instructions.
3. Heed all warnings.
4. Follow all instructions.
5. Do not use this apparatus near water.
6. Clean only with dry cloth.
7. Do not block any ventilation openings. Install in accordance with the manufacture's instructions.
8. Do not install near any heat sources such as radiators, heat registers, stoves, or other apparatus (including amplifiers) that produce heat.
9. Do not defeat the safety purpose of the polarized or grounding-type plug. A polarized plug has two blades with one wider than the other. A grounding type plug has two blades and a third grounding prong. The wide blade or the third prong are provided for your safety. If the provided plug does not fit into your outlet, consult an electrician for replacement of the obsolete outlet.
10. Protect the power cord from being walked on or pinched particularly at plugs, convenience receptacles, and the point where they exit from the apparatus.
11. Only use attachments/accessories specified by the manufacturer.

12. Use only with the cart, stand, tripod, bracket, or table specified by the manufacturer, or sold with the apparatus. When a cart is used, use caution when moving the cart/apparatus combination to avoid injury from tip-over.
13. Unplug this apparatus during lightning storms or when unused for long periods of time.
14. Refer all servicing to qualified service personnel. Servicing is required when the apparatus has been damaged in any way, such as power-supply cord or plug is damaged, liquid has been spilled or objects have fallen into the apparatus, the apparatus has been exposed to rain or moisture, does not operate normally, or has been dropped.



Additional Safety Information!

15. ⚡ Marked terminals are HAZARDOUS LIVE and that the external wiring connected to those terminal requires installation by an instructed person or the use of ready-made leads or cords.
16. This product is equipped with a three-wire grounding type plug, a plug having a third (grounding) pin. This plug will only fit into a grounding-type power outlet. If you are unable to insert the plug into the outlet, contact your electrician to replace your obsolete outlet. Do not defeat the safety purpose of the grounding-type plug.

CAUTION:

To completely disconnect this product from the mains, disconnect the plug from the wall socket outlet.

The mains plug is used to completely interrupt the power supply to the unit and must be within easy access by the user.

VORSICHT:

Um dieses Gerät vollständig von der Stromversorgung abzutrennen, trennen Sie bitte den Netzstecker von der Wandsteckdose ab.

Die Hauptstecker werden verwendet, um die Stromversorgung zum Gerät völlig zu unterbrechen; er muss für den Benutzer gut und einfach zu erreichen sein.

PRECAUTION:

Pour déconnecter complètement ce produit du courant secteur, débranchez la prise de la prise murale.

La prise secteur est utilisée pour couper complètement l'alimentation de l'appareil et l'utilisateur doit pouvoir y accéder facilement.

ATTENZIONE:

Per scollegare definitivamente questo prodotto dalla rete di alimentazione elettrica, togliere la spina dalla relativa presa.

La spina di rete viene utilizzata per interrompere completamente l'alimentazione all'unità e deve essere facilmente accessibile all'utente.

PRECAUCIÓN:

Para desconectar completamente este producto de la alimentación eléctrica, desconecte el enchufe del enchufe de la pared.

El enchufe de la alimentación se utiliza para interrumpir por completo el suministro de alimentación a la unidad y debe de encontrarse en un lugar al que el usuario tenga fácil acceso.

VOORZICHTIGHEID:

Om de voeding van dit product volledig te onderbreken moet de stekker uit het stopcontact worden getrokken.

De netstekker wordt gebruikt om de stroomtoevoer naar het toestel volledig te onderbreken en moet voor de gebruiker gemakkelijk bereikbaar zijn.

FÖRSIKTIHETSMÅTT:

Koppla loss stickproppen från eluttaget för att helt skilja produkten från nätet.

Stickproppen används för att helt bryta strömförsörjningen till apparaten, och den måste vara lättillgänglig för användaren.

NOTE ON USE / HINWEISE ZUM GEBRAUCH / OBSERVATIONS RELATIVES A L'UTILISATION / NOTE SULL'USO / NOTAS SOBRE EL USO / ALVORENS TE GEBRUIKEN / OBSERVERA

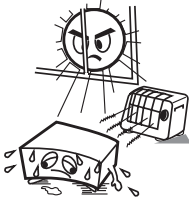

- Avoid high temperatures.
Allow for sufficient heat dispersion when installed on a rack.
- Vermeiden Sie hohe Temperaturen.
Beachten Sie, daß eine ausreichend Luftzirkulation gewährleistet wird, wenn das Gerät auf ein Regal gestellt wird.
- Eviter des températures élevées
Tenir compte d'une dispersion de chaleur suffisante lors de l'installation sur une étagère.
- Evitate di esporre l'unità a temperature alte.
Assicuratevi che ci sia un'adeguata dispersione del calore quando installate l'unità in un mobile per componenti audio.
- Evite altas temperaturas
Permite la suficiente dispersión del calor cuando está instalado en la consola.
- Vermijd hoge temperaturen.
Zorg voor een degelijk hitteafvoer indien het apparaat op een rek wordt geplaatst.
- Undvik höga temperaturer.
Se till att det finns möjlighet till god värmeavledning vid montering i ett rack.

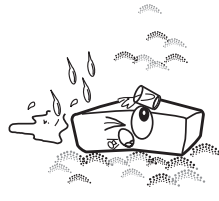

- Keep the set free from moisture, water, and dust.
- Halten Sie das Gerät von Feuchtigkeit, Wasser und Staub fern.
- Protéger l'appareil contre l'humidité, l'eau et la poussière.
- Tenete l'unità lontana dall'umidità, dall'acqua e dalla polvere.
- Mantenga el equipo libre de humedad, agua y polvo.
- Laat geen vochtigheid, water of stof in het apparaat binnendringen.
- Utsätt inte apparaten för fukt, vatten och damm.



- Do not let foreign objects in the set.
- Keine fremden Gegenstände in das Gerät kommen lassen.
- Ne pas laisser des objets étrangers dans l'appareil.
- E' importante che nessun oggetto è inserito all'interno dell'unità.
- No deje objetos extraños dentro del equipo.
- Laat geen vreemde voorwerpen in dit apparaat vallen.
- Se till att främmande föremål inte tränger in i apparaten.

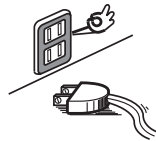

- Unplug the power cord when not using the set for long periods of time.
- Wenn das Gerät eine längere Zeit nicht verwendet werden soll, trennen Sie das Netzkabel vom Netzstecker.
- Débrancher le cordon d'alimentation lorsque l'appareil n'est pas utilisé pendant de longues périodes.
- Disinnestate il filo di alimentazione quando avete l'intenzione di non usare il filo di alimentazione per un lungo periodo di tempo.
- Desconecte el cordón de energía cuando no utilice el equipo por mucho tiempo.
- Neem altijd het netsnoer uit het stopcontact wanneer het apparaat gedurende een lange periode niet wordt gebruikt.
- Koppla ur nätkabeln om apparaten inte kommer att användas i lång tid.



- Do not let insecticides, benzene, and thinner come in contact with the set.
- Lassen Sie das Gerät nicht mit Insektiziden, Benzin oder Verdünnungsmitteln in Berührung kommen.
- Ne pas mettre en contact des insecticides, du benzène et un diluant avec l'appareil.
- Assicuratevi che l'unità non venga in contatto con insetticidi, benzolo o solventi.
- No permita el contacto de insecticidas, gasolina y diluyentes con el equipo.
- Laat geen insektenverdelgende middelen, benzine of verververdunner met dit apparaat in contact komen.
- Se till att inte insektsmedel på spraybruk, bensen och thinner kommer i kontakt med apparatens hölje.

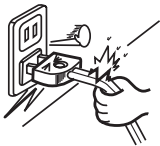

- Handle the power cord carefully.
Hold the plug when unplugging the cord.
- Gehen Sie vorsichtig mit dem Netzkabel um.
Halten Sie das Kabel am Stecker, wenn Sie den Stecker herausziehen.
- Manipuler le cordon d'alimentation avec précaution.
Tenir la prise lors du débranchement du cordon.
- Maneggiare il filo di alimentazione con cura.
Agite per la spina quando scollegate il cavo dalla presa.
- Maneje el cordón de energía con cuidado.
Sostenga el enchufe cuando desconecte el cordón de energía.
- Hanteer het netsnoer voorzichtig.
Houd het snoer bij de stekker vast wanneer deze moet worden aan- of losgekoppeld.
- Hantera nätkabeln varsamt.
Håll i kabeln när den kopplas från el-uttaget.



* (For sets with ventilation holes)

- Do not obstruct the ventilation holes.
- Die Belüftungsöffnungen dürfen nicht verdeckt werden.
- Ne pas obstruer les trous d'aération.
- Non coprite i fori di ventilazione.
- No obstruya los orificios de ventilación.
- De ventilatieopeningen mogen niet worden geblokkeerd.
- Tapp inte till ventilationsöppningarna.



- Never disassemble or modify the set in any way.
- Versuchen Sie niemals das Gerät auseinander zu nehmen oder auf jegliche Art zu verändern.
- Ne jamais démonter ou modifier l'appareil d'une manière ou d'une autre.
- Non smontate mai, nè modificate l'unità in nessun modo.
- Nunca desarme o modifique el equipo de ninguna manera.
- Nooit dit apparaat demonteren of op andere wijze modificieren.
- Ta inte isär apparaten och försök inte bygga om den.

CAUTION

- The ventilation should not be impeded by covering the ventilation openings with items, such as newspapers, tablecloths, curtains, etc.
- No naked flame sources, such as lighted candles, should be placed on the apparatus.
- Attention should be drawn to the environmental aspects of battery disposal.
- The apparatus shall not be exposed to dripping or splashing for use.
- No objects filled with liquids, such as vases, shall be placed on the apparatus.

•DECLARATION OF CONFORMITY

We declare under our sole responsibility that this product, to which this declaration relates, is in conformity with the following standards:

EN60065, EN55013, EN55020, EN61000-3-2 and EN61000-3-3.

Following the provisions of 73/23/EEC, 2004/108/EC and 93/68/EEC Directive.

•ÜBEREINSTIMMUNGSERKLÄRUNG

Wir erklären unter unserer Verantwortung, daß dieses Produkt, auf das sich diese Erklärung bezieht, den folgenden Standards entspricht:

EN60065, EN55013, EN55020, EN61000-3-2 und EN61000-3-3.

Entspricht den Verordnungen der Direktive 73/23/EEC, 2004/108/EC und 93/68/EEC.

•DECLARATION DE CONFORMITE

Nous déclarons sous notre seule responsabilité que l' appareil, auquel se réfère cette déclaration, est conforme aux standards suivants:

EN60065, EN55013, EN55020, EN61000-3-2 et EN61000-3-3.

D'après les dispositions de la Directive 73/23/EEC, 2004/108/EC et 93/68/EEC.

•DICHIARAZIONE DI CONFORMITÀ

Dichiariamo con piena responsabilità che questo prodotto, al quale la nostra dichiarazione si riferisce, è conforme alle seguenti normative:

EN60065, EN55013, EN55020, EN61000-3-2 e EN61000-3-3.

In conformità con le condizioni delle direttive 73/23/EEC, 2004/108/EC e 93/68/EEC.

QUESTO PRODOTTO E' CONFORME

AL D.M. 28/08/95 N. 548

•DECLARACIÓN DE CONFORMIDAD

Declaramos bajo nuestra exclusiva responsabilidad que este producto al que hace referencia esta declaración, está conforme con los siguientes estándares:

EN60065, EN55013, EN55020, EN61000-3-2 y EN61000-3-3.

Siguiendo las provisiones de las Directivas 73/23/EEC, 2004/108/EC y 93/68/EEC.

•EENVORMIGHEIDSVERKLARING

Wij verklaren uitsluitend op onze verantwoordelijkheid dat dit produkt, waarop deze verklaring betrekking heeft, in overeenstemming is met de volgende normen:

EN60065, EN55013, EN55020, EN61000-3-2 en EN61000-3-3.

Volgens de bepalingen van de Richtlijnen 73/23/EEC, 2004/108/EC en 93/68/EEC.

•ÖVERENSSTÄMMELSESINTYG

Härmed intygas helt på eget ansvar att denna produkt, vilken detta intyg avser, uppfyller följande standarder:

EN60065, EN55013, EN55020, EN61000-3-2 och EN61000-3-3.

Enligt stadgarna i direktiv 73/23/EEC, 2004/108/EC och 93/68/EEC.

CLASS 1 LASER PRODUCT
LUOKAN 1 LASERLAITE
KLASS 1 LASERAPPARAT

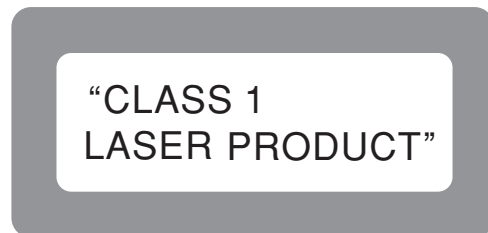

ADVARSEL: USYNLIG LASERSTRÅLING VED ÅBNING, NÅR SIKKERHEDSAFBRYDERE ER UDE AF FUNKTION. UNDGÅ UDSAETTELSE FOR STRÅLING.

VAROITUS! LAITTEEN KÄYTTÄMINEN MUULLA KUIN TÄSSÄ KÄYTTÖOHJEESSA MAINITULLA TAVALLA SAATTAA ALTISTAA KÄYTTÄJÄN TURVALLISUUSLUOKAN 1 YLITTÄVÄLLE NÄKYMÄMTTÖMÄLLE LASERSÄTEILYLLE.

VARNING-- OM APPARATEN ANVÄNDS PÅ ANNAT SÄTT ÄN I DENNA BRUKSANVISNING SPECIFICERATS, KAN ANVÄNDAREN UTSÄTTAS FÖR OSYNLIG LASERSTRÅLNING SOM ÖVERSKRIDER GRÄNSEN FÖR LASERKLASS 1.





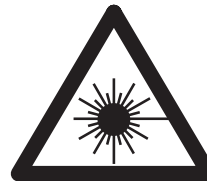

ATTENZIONE: QUESTO APPARECCHIO E' DOTATO DI DISPOSITIVO OTTICO CON RAGGIO LASER.

L'USO IMPROPRIO DELL'APPARECCHIO PUO' CAUSARE PERICOLOSE ESPOSIZIONI A RADIAZIONI!!



CAUTION:
USE OF CONTROLS OR ADJUSTMENTS OR PERFORMANCE OF PROCEDURES OTHER THAN THOSE SPECIFIED HEREIN MAY RESULT IN HAZARDOUS RADIATION EXPOSURE.
THIS PRODUCT SHOULD NOT BE ADJUSTED OR REPAIRED BY ANYONE EXCEPT PROPERLY QUALIFIED SERVICE PERSONNEL.



- Use compact discs that include the  mark.
CD's with special shapes (heart-shaped CD's, octagonal CD's etc.) cannot be played on this set.
Attempting to do so may damage the set. Do not use such CD's.
- Benutzen Sie Compact Discs, die das  Zeichen tragen.
Speziell geformte CD's (herzförmige CDs, achteckige CDs, usw.) können auf dieser Anlage nicht abgespielt werden.
Der Versuch derartige CDs abzuspielen kann die Anlage beschädigen. Verzichten Sie auf die Benutzung solcher CDs.
- Utiliser des disques compacts portant le logo .
Des CD avec des formes spéciales (CD en forme de coeur, des CD octogonaux, etc.) ne peuvent pas être lus sur cet appareil.
Le fait de l'essayer, risque d'endommager le lecteur. Ne pas utiliser de tels CD.
- Usare compact disc che includono il marchio .
I CD con forme particolari (CD a forma di cuore, CD ottagonali ecc.) non possono essere riprodotti su questo apparecchio.
L'apparecchio si potrebbe danneggiare se si cerca di farlo.
Non utilizzare questi CD.
- Use discos compactos con la marca .
En este equipo no es posible reproducir CDs con formas especiales (CDs con forma de corazón, CDs octogonales, etc.).
Si intenta hacerlo, el equipo podrá resultar dañado. No use este tipo de CDs.
- Gebruik compact discs voorzien van het logo .
CD's met speciale vormen (bijv. CD's in de vorm van een hart, achthoekige CD's, enz.) kunnen met dit toestel niet worden afgespeeld.
Wanneer u dit toch probeert, zal u het toestel beschadigen.
Speel dergelijke CD's dus niet af.
- Använd CD-skivor med -märket.
Specialformade CD-skivor (hjärtformade, åttkantiga, m m) går inte att spela på den här apparaten.
Utrustningen kan skadas om du försöker göra detta.
Använd inte CD-skivor av denna typ.

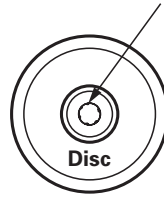

Residue
Rückstand
Résidu
Residuo
Residuos
Oneffenheid
Plastrester

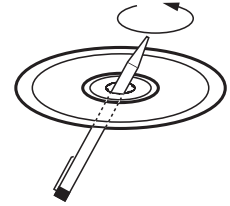

- The disc may not play normally if there is residue along the edges of the center hole.
- When using new discs in particular, use a pen, etc., to remove the residue.
- Die Disk kann nicht normal abgespielt werden, wenn sich ein Rückstand entlang der Mittellochenden befindet.
- Insbesondere, wenn Sie neue Disks benutzen, dann entfernen Sie mit einem Stift, etc. den Rückstand.
- Le disque peut ne pas être lu normalements s'il y a un résidu le long des bord du trou central.
- Lors de l'utilisation de nouveaux disques en particulier, utiliser un stylo à bille, etc., pour enlever le résidu.
- Il disco può non essere riprodoto in modo normale se ci sono dei residui lungo I bordi del foro centrale.
- Usate una penna, ecc., per rimuovere I residui, specialmente quando usate dischi nuovi.
- El disco no puede ser reproducido normalmente debido a la terminación deficiente de los bordes del agujero central.
- Para quitar estos residuos de material, especialmente cuando vaya a re-reproducir discos nuevos, utilice un bolígrafo, o algo similar.
- Het is mogelijk dat de disc niet normaal wordt weergegeven als de randen van het middengat van de schijf oneffenheden vertonen.
- Verwijder vooral bij gebruik van nieuwe discs de oneffenheden met een pen of iets dergelijks.
- Det kan uppstå fel vid CD-avspelningen om det finns plastrester kvar i mitthålet.
- Tänk på att bort dessa med en penna, e d, särskilt om CD-skivan är ny.



- This unit can display text information on the display when playing CD text discs which contain text information in English category.

The CD text disc includes the mark shown above.

NOTE:

- This unit can provide a text display of the following types of characters. Other types of characters will result in " " being displayed.

- Alphabet

ABCDEFGHIJKLMNOPQRSTUVWXYZ
abcdefghijklmnopqrstuvwxyz

- Numbers

0123456789

- Symbols

!"#\$%&'()*+,-./:;=<>
?@[#]_`^{}~SPACE

- Bei der Wiedergabe von CD-Textdiscs, die Funktionstasten in englischer Kategorie enthalten, kann dieses Gerät auf dem Display Funktionstasten anzeigen. Die CD-Textdiscs sind mit dem rechts dargestellten Logo versehen.

HINWEIS:

- Dieses Gerät kann aus den nachfolgend aufgeführten Zeichenarten bestehende Texte anzeigen. Bei anderen Zeichenarten wird " " angezeigt.

- Alphabet

ABCDEFGHIJKLMNOPQRSTUVWXYZ
abcdefghijklmnopqrstuvwxyz

- Zahlen

0123456789

- Symbole

!"#\$%&'()*+,-./:;=<>
?@[#]_`^{}~SPACE

- Cet appareil peut afficher les textes d'information lors de la lecture de CD qui comportent ces textes, dans la catégorie anglaise.

Les CD avec texte se repèrent à la marque indiquée à droite.

REMARQUE:

- Cet appareil permet l'affichage de textes composés avec les types de caractères suivants. Tous les autres types de caractères seront affichés ainsi " ".

- Alphabétiques

ABCDEFGHIJKLMNOPQRSTUVWXYZ
abcdefghijklmnopqrstuvwxyz

- Chiffres

0123456789

- Symboles

!"#\$%&'()*+,-./:;=<>
?@[#]_`^{}~SPACE

- Quest'unità può visualizzare dei testi sul display durante la riproduzione di CD che contengono dei testi in inglese. Il disco CD con testi include il marchio mostrato qui a destra.

NOTA:

- Quest'unità è in grado di fornire una visualizzazione dei testi usando i seguenti tipi di caratteri. Altri tipi di caratteri causeranno la visualizzazione dell'indicazione " ".

- Alfabeto

ABCDEFGHIJKLMNOPQRSTUVWXYZ
abcdefghijklmnopqrstuvwxyz

- Numeri

0123456789

- Simboli

!"#\$%&'()*+,-./:;=<>
?@[#]_`^{}~SPACE

- Esta unidad puede mostrar información de texto en la pantalla cuando se reproducen discos CD de Texto que contengan información de texto en la categoría de Inglés. Los discos CD de Texto incluyen la marca indicada a la derecha.

NOTA:

- Esta unidad puede mostrar visualizaciones de texto de los siguientes tipos de caracteres. Otros tipos de caracteres harán que se visualice " ".

- Alfabeto

ABCDEFGHIJKLMNOPQRSTUVWXYZ
abcdefghijklmnopqrstuvwxyz

- Números

0123456789

- Símbolos

!"#\$%&'()*+,-./:;=<>
?@[#]_`^{}~SPACE

- Dit toestel kan tekstinformatie op het display tonen bij het weergeven van CD-Text discs met tekstinformatie in de categorie Engels. Een CD-Text disc is voorzien van het logo rechts.

OPMERKING:

- Dit toestel kan de volgende tekens als tekst weergeven. Voor andere types van tekens verschijnt " " op het display.

- Alfabet

ABCDEFGHIJKLMNOPQRSTUVWXYZ
abcdefghijklmnopqrstuvwxyz

- Getallen

0123456789

- Symbolen

!"#\$%&'()*+,-./:;=<>
?@[#]_`^{}~SPACE

- Denna apparat kan visa text på displayen när du spelar CD-textskivor innehållande information på engelska. CD text-skivor bär märket som anges på höger sida.

OBSERVERA:

- Apparaten kan visa text med följande teckentyper. För övriga tecken kommer " " att visas.

- Alfabetiska

ABCDEFGHIJKLMNOPQRSTUVWXYZ
abcdefghijklmnopqrstuvwxyz

- Siffror

0123456789

- Symboler

!"#\$%&'()*+,-./:;=<>
?@[#]_`^{}~SPACE

– TABLE OF CONTENTS –

1. GENERAL INFORMATION	2
FEATURES.....	2
PART NAMES AND FUNCTIONS	3
2. PREPARATIONS	9
INSTALLATION.....	9
CONNECTIONS.....	10
3. DEVICE OPERATION	11
SUPPORTED AUDIO CD	11
INSERTING AND EJECTING A DISC	11
NORMAL CD PLAYBACK	12
ADVANCED CD PLAYBACK.....	14
PLAYING AUDIO FILES.....	17
PRESET FUNCTIONS AND OPERATIONS	20
UTILITY MENU.....	26
4. NETWORK FUNCTIONALITY AND OPERATION.....	28
Network functionality and Operation	28
How to hook up the DN-C640 to your network.....	28
Setting up a Shared Folder on a Server or a Network Server	29
5. CONTROL FEATURES	30
WEB REMOTE	30
RS-232C CONTROL	36
GPIO (Parallel) CONTROL	41
6. TROUBLESHOOTING	43
7. SPECIFICATIONS	44

■ ACCESSORIES

Check that the following parts are included in addition to the main unit:

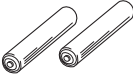
① Remote Control Unit (RC-1061).....	1
	
② Size "AAA" batteries	2
	
③ Audio Cord (Stereo).....	1
④ AC Power Cord	1
(Europe models)	2
⑤ Operating Instructions	1
⑥ Warranty card.....	1

A NOTE ABOUT RECYCLING:

This product's packaging materials are recyclable and can be reused. Please dispose of any materials in accordance with the local recycling regulations.

When discarding the unit, comply with local rules or regulations.

Batteries should never be thrown away or incinerated but disposed of in accordance with the local regulations concerning chemical waste.

This product and the accessories packed together constitute the applicable product according to the WEEE directive except batteries.



1. GENERAL INFORMATION

FEATURES

■ **Standard Functions of Professional CD Player**

- Slot-In Disc Drive
- Reads and Displays CD TEXT & MP3 ID3 Tags
- Quick Track Search with Jog Wheel
- Cue to Music
- Balanced Audio Output with Trim
- 2 Sets of Unbalanced Audio Outputs (1 Fixed / 1 Variable level)
- SPDIF and AES/EBU Digital Audio Output
- Plays Back Audio Files from a CD or DVD Data Disc
- Reads CD-R / CD-RW / DVD-R / DVD-RW / DVD+R / DVD+RW discs
- Supports CD-DA, WAVE, MPEG-1/2 Layer III (MP3), MPEG-1/2 Layer II (MP2), WMA

■ **Advanced CD Playback**

- Quick Replay (Skip Back) (Time programmable)
- +/- 12% Variable Pitch Control
- Program Play
- Single, All, A-B Repeat modes
- Random Play mode
- User – Selectable Finish Mode (Stop, Next, Recue, Continuous)
- Auto Cue
- End Monitor
- End of Message (EOM) indicator

■ **Network Audio Playback – Streams Audio from Shared Network Resources**

- Uploads Audio Files from Disc to the Network Drive

■ **19-inch 1U rack space**

■ **IR Remote Control (Remote controller RC-1061 included)**

■ **Embedded Web Browser Control**

- Remote Control Same as Panel Operation
- Up/Downloadable Program Playlists
- Preset setting

■ **External Remote Control**

- Serial control (RS232C)
- Parallel control

PART NAMES AND FUNCTIONS

(1) Front panel

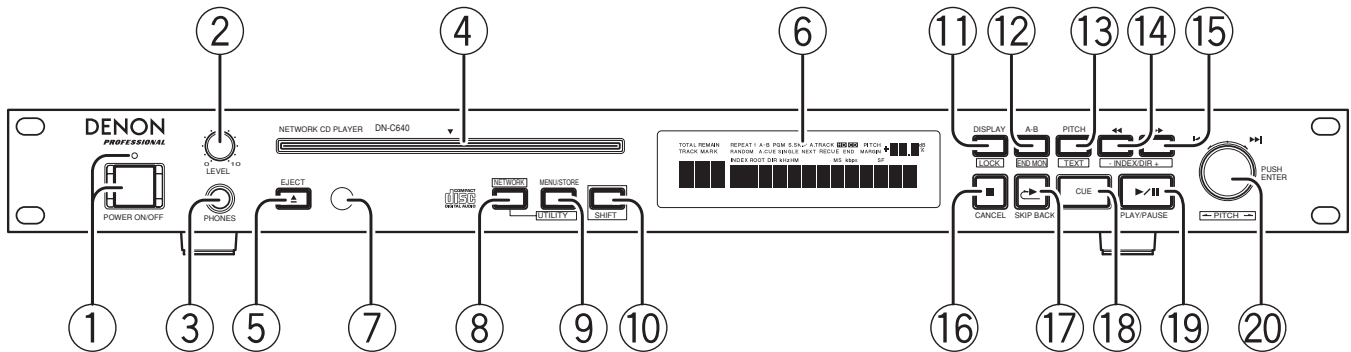
**① POWER ON/OFF switch and indicator**

- Press this to turn the Power ON or OFF.
- The indicator lights when the power is turned on.

② LEVEL control

- Use this to adjust the output level of the headphones.

Warning!

- When using headphones, take care not to turn the volume too high. Listening at high volumes for extended periods of time may result in permanent hearing damage.

③ PHONES Jack

- For private listening, you can connect your headphones to this jack.

④ DISC slot

- Insert a CD or DVD into the slot, label side upwards.

⑤ EJECT button

- Press this to eject the disc. The EJECT button is locked when Eject Lock is on in the preset menu and the unit is in PLAY mode.

⑥ Display unit

- Refer to page 6 for details.

⑦ Remote control sensor**⑧ NETWORK button and indicator (Blue)**

- Press this to select between the network drive or internal drive.
- The indicator lights when the network drive is selected.

⑨ MENU/STORE/UTILITY button

- Press to enter the preset menu or to store changes made in the preset menu.
- In shift mode, press this button to enter the utility menu.

⑩ SHIFT button and indicator (Amber)

- Press to turn the shift mode on or off. When in shift mode, the indicator lights.
- Press this button again to exit shift mode.

⑪ DISPLAY/LOCK button

- Press this to change the time mode on the display.
- In shift mode, press and hold this more than three seconds to lock or unlock the controls on the front panel.

⑫ A-B/END MON button

- Use this to play a set section repeatedly. When the button is pressed once during playback, that position is set as the A point and the "A-" indicator flashes on the display.
- When the button is pressed again, that position is set as the B point, the "A-B" indicator stops flashing (remaining lit), and the A-B section begins playing repeatedly.
- When the button is pressed again, A-B repeat is canceled and the mode returns to the normal play mode.
- In shift mode, press this button to start the End Monitor.

⑬ PITCH button and indicator (Amber)/TEXT button

- Press this button to switch the PITCH on or off.
- In shift mode, press this button to display the text information.

1. GENERAL INFORMATION

⑭ ⑮ ◀ ▶ / – INDEX/DIR + button

- These buttons are used to accurately change the positions where playback will start or operate as FF or FR when held down.
- In shift mode, use this button to select the index (Audio CDs) or directory (music file discs).

⑯ STOP/CANCEL button

- Press this button to stop playback.
- Press this to cancel a selection in program setting.
- During preset setting operations, press to cancel all entries made and return to stop mode.

⑰ SKIP BACK button

- Press this button for instant replay at the currently playing audio. The amount of time skipped back is adjustable in the preset menu.

⑱ CUE button and indicator (Amber)

- When pressed during playback, the pickup returns to the position at which playback last started or the next track and the CUE mode is set.
- When pressed during manual search, the CUE mode is set at that position.

⑲ PLAY/PAUSE button and indicator (Green)

- Use this button to start playback or pause playback.

⑳ Jog wheel with PUSH/ENTER button

- Turn the jog wheel clockwise by one click to move one track forward, counterclockwise by one click to move one track backward.
- In the preset mode, turn the jog wheel to select the preset item and push to enter.
- In the utility mode, turn the jog wheel to select the preset item and push to enter.
- In the shift mode, use this jog wheel to set the pitch value.
- In the stop mode or in the play/pause mode, push this to start playback.

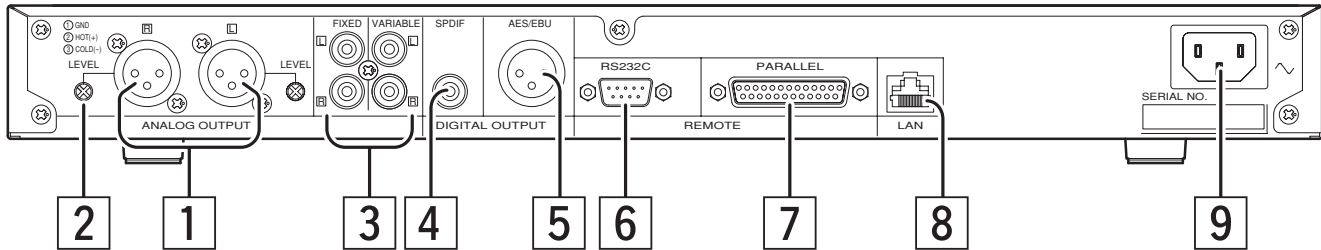
(2) Rear panel**1 ANALOG (Balanced) OUTPUT**

- These are active balanced outputs using XLR type connections. The CD's or network's audio playback signals are output from these connectors.
- Pin layout : 1. GND / 2. Hot / 3. Cold
- Applicable connector :
Canon XLR-3-31 or equivalent.

NOTE :

- Do not short-circuit the hot or cold pin with the common pin.

2 LEVEL Control

- Use these controls to adjust the level of the audio signals from the BALANCED OUT connectors.

3 ANALOG (Unbalanced) OUTPUT

- These are unbalanced outputs using RCA type jacks.
- VARIABLE
Use the remote control unit or web GUI to adjust the output level.

4 DIGITAL (SPDIF) OUTPUT

- This is a coaxial output using an RCA type jack.
- Signal format : SPDIF(IEC-958 Type II) or AES/EBU (select in menu)
- Sampling frequency : 32 /44.1 /48 /Auto (select in menu)

5 DIGITAL (AES/EBU) OUTPUT

- This is a balanced output using an XLR type jack.
1.Common / 2.Hot / 3.Cold.
- Signal format : SPDIF(IEC-958 Type II) or AES/EBU (select in menu)
- Sampling frequency : 32 /44.1 /48 /Auto (select in menu)
- Applicable connector: canon XLR-3-31 or equivalent

6 RS232C connector

Connector for serial control from an external device.

7 PARALLEL connector

Connector for parallel control from an external device.

8 LAN connector

10BASE-T and 100BASE-TX RJ-45 LAN terminal for network connection.

9 AC inlet

Connect the included power cord here.

1. GENERAL INFORMATION

(3) Display

Specific Icons and Character displays inform you of the current operating status and menu items of the device.

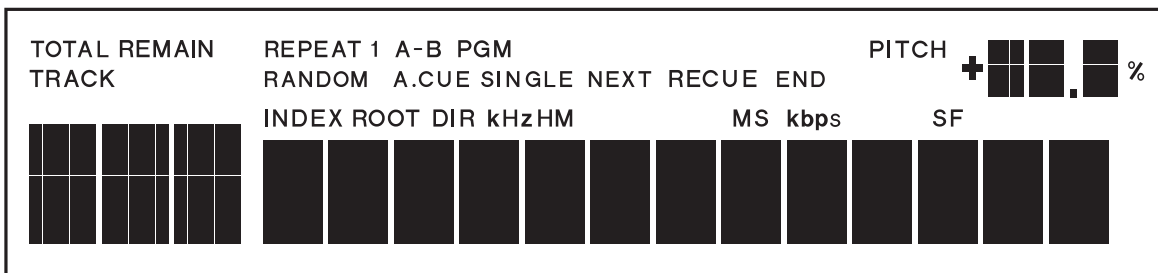

[Basic CD Operation]

“TOTAL” illuminates to indicate that the time displayed is the TOTAL time of the track or file.
 “TOTAL” can also be lit with “TRACK” in stop mode to indicate the total number of tracks or files in the current disc or directory.
 “REMAIN” illuminates to indicate that the time displayed is the remaining time of the currently playing track.
 “REMAIN” can also be lit with the “TOTAL” icon to indicate the TOTAL REMAINING time of the disc.
 Both icons off indicates that the time displayed is the ELAPSED time of the currently playing track or file.

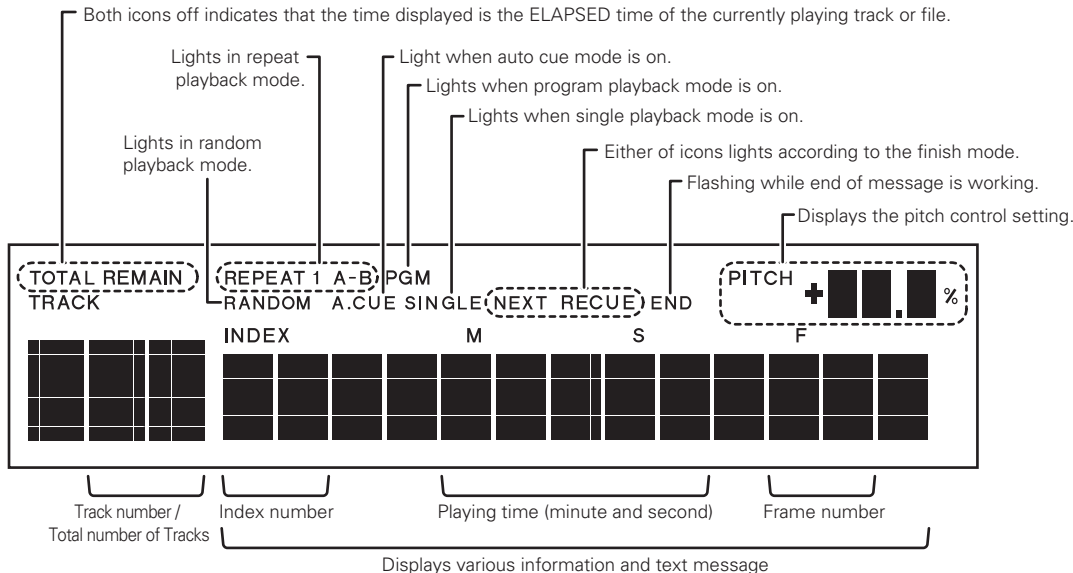

[Audio file Operation]

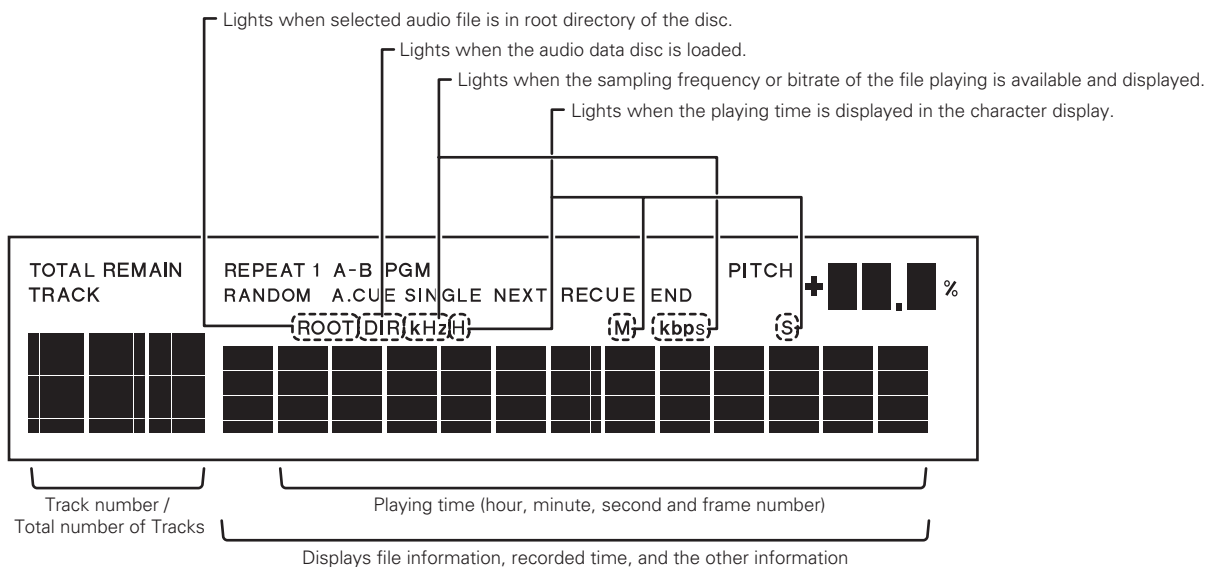

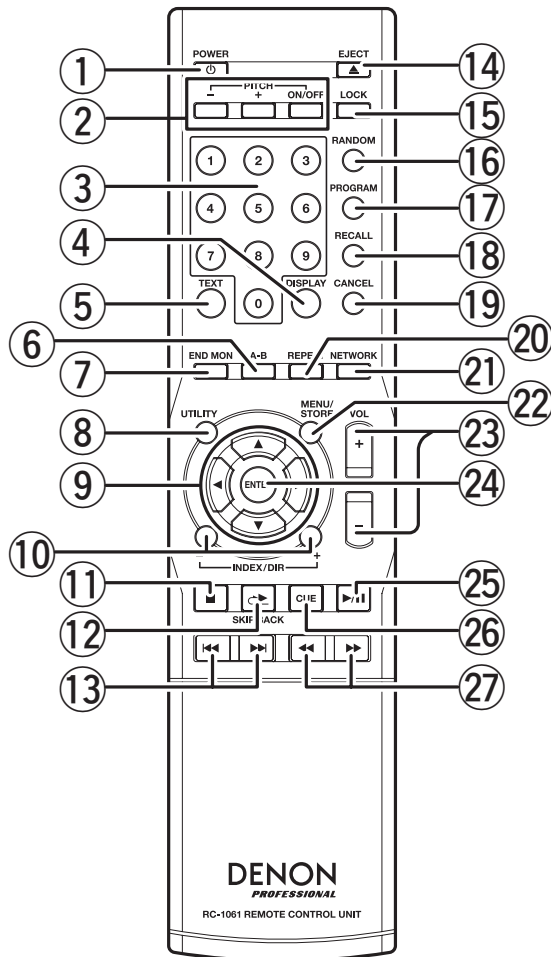
(4) Remote control unit (RC-1061)**① POWER button**

Press this to turn the power on or off.

② PITCH +/- buttons

Press these buttons to adjust the Pitch up(+) or down(-).

PITCH ON/OFF button

Press this to turn the pitch control function on or off.

③ 0-9 buttons

Press these to select the desired track in the stop mode.

④ DISPLAY button

Press this to change the time mode on the display.

⑤ TEXT button

Press this to display the CD Text or ID3 tag information.

⑥ A-B button

Press this to set or cancel the A-B repeat function.

⑦ END MON button

Press this to start the End Monitor function.

⑧ UTILITY button

Press this to enter the Utility menu.

⑨ ▲ / ▼ / ◀ / ▶ buttons

Use these for menu selection and ◀ / ▶ for track selection.

⑩ INDEX+/- buttons

Press this to select the index (Audio CDs) or directory (Audio data discs / Network drive).

⑪ STOP button

Press this to stop the playback.

⑫ SKIP BACK button

Press this for instant replay of the currently playing audio.

⑬ ◀◀ / ▶▶ buttons

Press these to skip from track to track or file to file.

⑭ EJECT button

Press this to eject the disc.

⑮ LOCK button

Press this to lock or unlock the buttons on the front panel.

⑯ RANDOM button

Press this to set the random playback mode.

⑰ PROGRAM button

Press this to enter the program mode.

⑱ RECALL button

Press this to recall the programmed track.

⑲ CANCEL button

Press this to cancel a selection in program setting.

⑳ REPEAT button

Press this to set repeat playback.

㉑ NETWORK button

Press this to switch between the network drive or internal drive.

㉒ MENU/STORE button

Press this to enter the preset menu or to store changes made in the preset menu.

1. GENERAL INFORMATION

23 VOL+/- buttons

Press these to change the playback volume output through the unbalanced VARIABLE Output jacks.

24 ENTER button

Press this to confirm selections in the menus.

25 PLAY/PAUSE button

Press this to start playback or pause playback.

26 CUE button

Press this to return to the position at which playback started or the next track.

27 << / >> buttons

Press this to accurately change the positions where playback will start or operate as FF or FR when held down.

• Operational range

As shown in the figure below, the player can be operated by the remote control unit in a range which of about 5 meters from the player's remote sensor and over an angle up to 30 degrees to the left and 30 degrees to the right of the position directly in front.

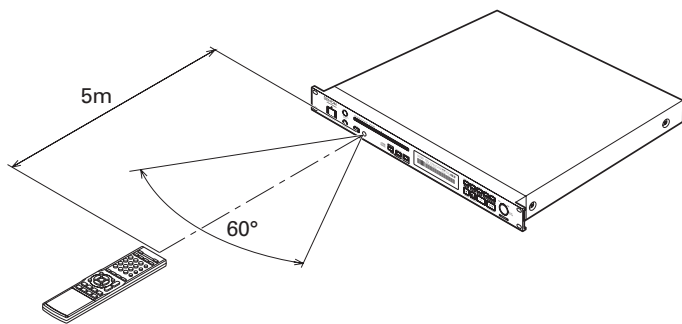

• Loading batteries

Before using the supplied remote control unit for the first time, load the batteries in the remote control unit. The batteries provided are used to verify the operations of the remote control unit only.

1. Take hold of the tab on the battery cover which is found on the back side of the remote control unit, and pull it up.

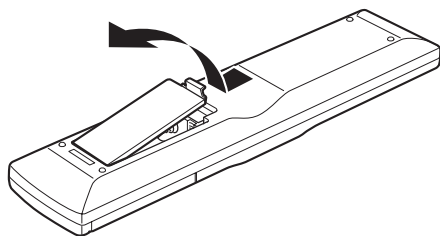

2. Load the two new size "AAA" batteries inside the battery compartment while taking care to align their polarities correctly with the polarity markings (+ with + and - with -).

Size "AAA" (UU-4) batteries x 2

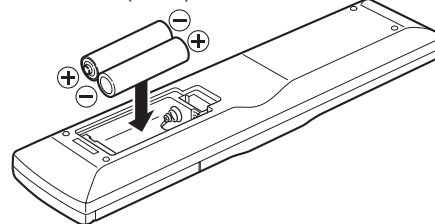

3. Push the battery cover down in the direction of the arrow to close it.

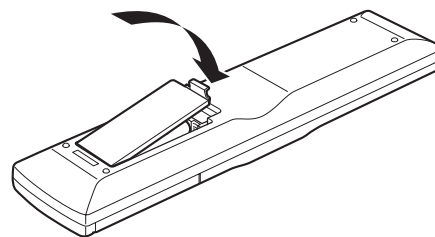

CAUTION:

Misuse of the batteries can result in electrolyte leakage, rupturing, corrosion, etc.

Bear in mind the following points when using batteries.

- Remove the batteries from the remote control unit if the unit is not going to be used for a prolonged period (a month or more).
- Do not use an old battery together with a new one.
- Insert the batteries while ensuring that their + and - poles are properly aligned with the corresponding markings on the remote control unit.
- Batteries with the same shape may have different voltages. Do not use different types of batteries together.
- If electrolyte has leaked, thoroughly wipe the inside of the battery compartment, and then insert new batteries.

2. PREPARATIONS

INSTALLATION

■ Mounting in a rack

- The DN-C640 is of 1U size, allowing it to be mounted in EIA standard 19-inch racks.
When mounting the DN-C640 in a rack, use guide rails or shelf boards, etc., on the rack side to prevent weight from being applied to the front of the DN-C640. The fittings alone cannot support the weight of the DN-C640 (4.3 kg).
Do not cover the top of the unit. Remember, heat is dispersed from the DN-C640's upper surface.
- Set up the installation environment carefully. For example, take care to protect the DN-C640 from heat from other devices. If necessary, use forced ventilation. The surrounding conditions must meet the specifications described in "SPECIFICATIONS" on Page 44.
- The DN-C640 will work normally when the player unit is mounted with the front panel within 10 degrees of the vertical plane. If the unit is tilted excessively, discs may not load or unload properly.

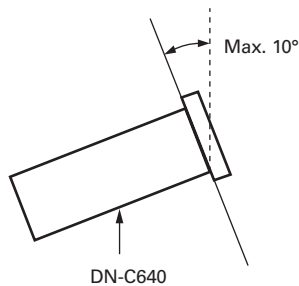

- If the DN-C640 is placed near an amplifier, tuner or other components, noise (induced hum) or beat interference may result (especially during AM or FM reception).
If this occurs, separate the DN-C640 from other components or reorient its position.

2. PREPARATIONS

CONNECTIONS

Leave your entire system (including the DN-C640) turned off until all connections between the DN-C640 and other components have been completed.

■ Connection precautions

- Before proceeding with connections or disconnections of cables and power cords, be sure to turn all system components off.
- Ensure that all cables are connected properly to the L (left) and R (right) jacks.
- Insert plugs fully into the terminals.
- Connect the CD output jacks to the amplifier CD or AUX input jacks.
- Connect one end of a straight-through RS-232 serial cable into Communication Port on the back of the DN-C640 and connect the other end into the "RS-232C" port on the back of the computer.
- Connect the DN-C640 to your network using a straight-through Ethernet cable or directly to a non-networked computer using a cross-over cable.

■ Basic connection

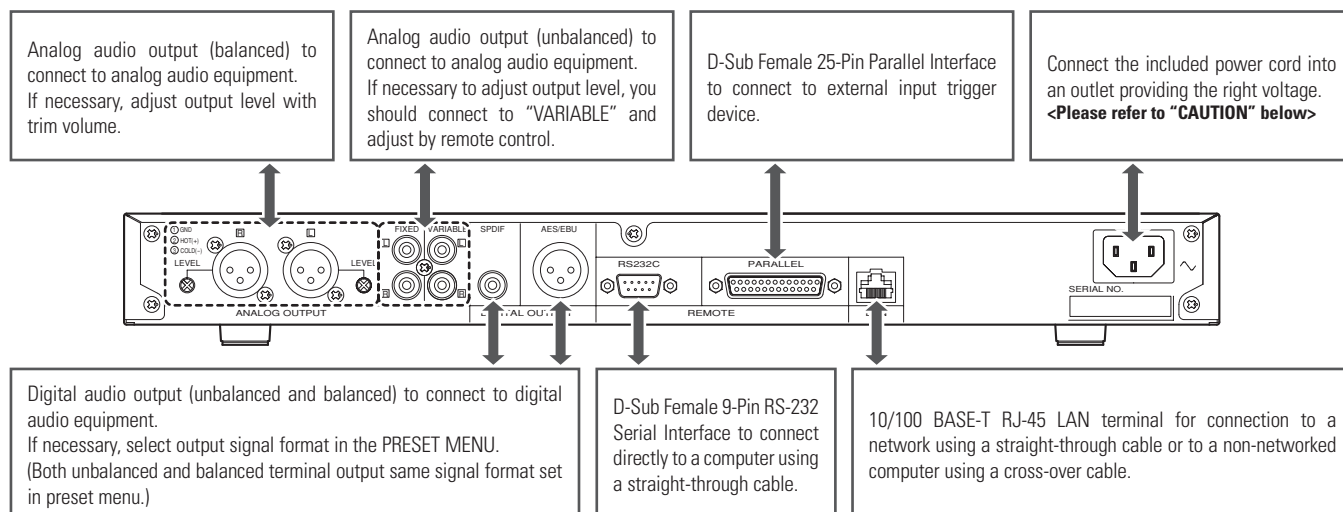



CAUTIONS:

- Before connecting, the POWER ON/OFF switch should be set the OFF position.
- Do not touch the power cord with wet hands.
- When disconnecting the power cord, always make sure that you take hold of the plug. Yanking out or bending the cord can damage it and/or cause electric shocks or a fire.

3. DEVICE OPERATION

SUPPORTED AUDIO CD

In addition to standard CD-DA discs, the DN-C640 can read several other CD-DA formats. Please refer to page 17 for detail of reading and operation of data discs.

Compact Disc Digital Audio (CD-DA)	
Compact Disc TEXT (CD TEXT)	
Enhanced Music CD (CD EXTRA)	

NOTE:

- Some copy-controlled CDs may not conform to official CD standards. They are special discs and may not play on the DN-C640.

INSERTING AND EJECTING A DISC

Inserting and Ejecting a disc is only available when the unit is powered on.

1. If the unit is OFF, press the **POWER ON/OFF** switch to turn on the power.
2. Hold the disc by the edges and insert it in the DISC slot. (Do not touch the signal surface, i.e., glossy side.)
3. Press the **EJECT** button to eject the disc.

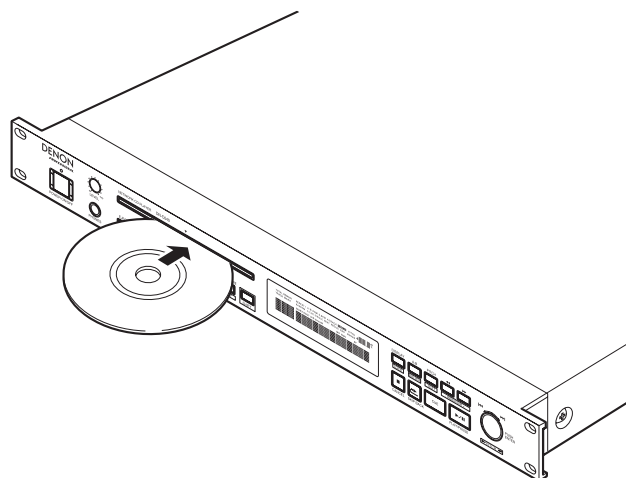

■ **Messages**

Messages may appear on the display while using the DN-C640.

The meaning of message are explained below.

Message	Meaning
No Disc	No disc is inserted.
Eject Locked	Unit is playing and Eject lock is on in the preset menu.

CAUTIONS:

- Do not push in the disc manually when the power is off as this may cause malfunction and damage the CD player.

3. DEVICE OPERATION

NORMAL CD PLAYBACK

(1) Before Starting Playback

1. Press the **POWER ON/OFF** switch to turn on the power.

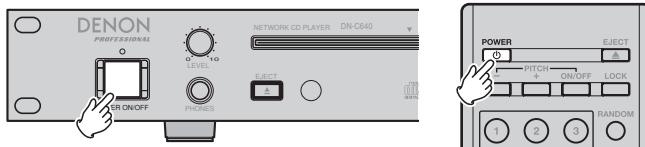

2. Load the disc you want to play.
3. Make sure the Preset Menu settings are set accordingly for the intended use. (See Page 22.)

(2) Starting Playback

1. Press the **PLAY/PAUSE** button.

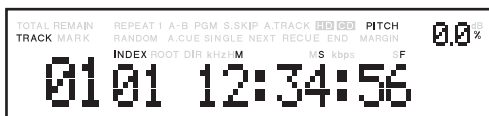
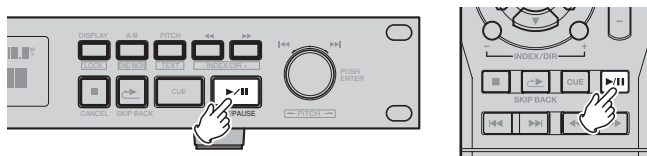

(3) Pausing playback at any point

Playback can be temporarily halted and then continued from the same point in the track.

1. Press the **PLAY/PAUSE** button during playback. (Button Flashes when in PAUSE mode)

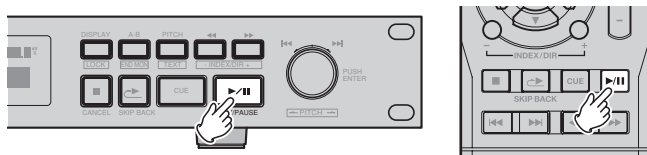

2. To continue playback, press the **PLAY/PAUSE** button.

(4) Returning to the position at which playback started

Set the CUE mode to RECUE in the preset menu and press the **CUE** button during playback, the pickup returns to the position at which playback started and the pause mode is set.

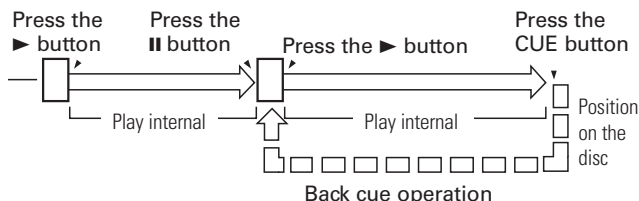
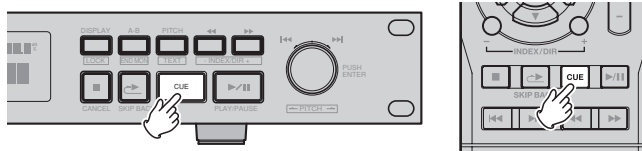

(5) Stopping playback

1. Press the **STOP/CANCEL** button.

(6) Advancing to the next track during playback

1. Turn the **jog wheel** clockwise or press the **▶▶** button during playback.

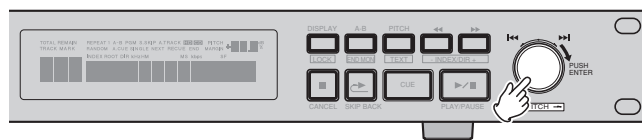

- The pickup will advance to the beginning of the next track and playback will continue when the Start mode is set to "Play" in the preset menu.
- The pickup will advance to the beginning of the next track and remain in CUE mode when the Start mode is set to "Stop" or "Cue" in the preset menu. (See Page 22 for Start Mode Settings)

NOTE:

- When the Next track reserve mode is set to "ON" in the preset menu, if you turn the **jog wheel** during playback, the track number indication of the display will blink and you can select the track to play next.

(7) Returning to the beginning of the current track during playback

1. Turn the **jog wheel** counterclockwise or press the **⏮** button during playback.

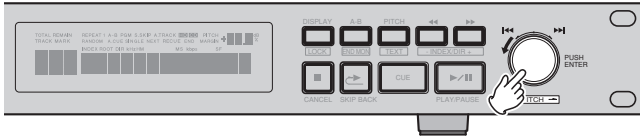

- The pickup will return to the beginning of the current track and playback will continue when the Start mode is set to "Play" in the preset menu.
- The pickup will return to the beginning of the current track and remain in CUE mode when the Start mode is set to "Stop" or "Cue" in the preset menu.

NOTE:

- When the Next track reserve mode is set to "ON" in the preset menu, if you turn the **jog wheel** during playback, the track number indication of the display will blink and you can select the track to play next.

(8) Audible quick search

- Using this function, you can search for a desired point quickly within a track in the both forward or reverse direction.
- When a **SEARCH** button is pressed during the pause mode and the button is released, the pause mode is cancelled at that point with the sound being output.

Manual search forward

1. Press the **SEARCH** (▶▶) button during playback.

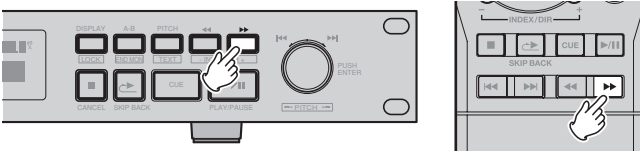

- The playback mode is cancelled, and the search point is reproduced repeatedly.
- Every time the **SEARCH** (▶▶) button is pressed the playback point advances one frame.
- Playback of the track is sped up while the **SEARCH** (▶▶) button is pressed.

Manual search in reverse

1. Press the **SEARCH** (◀◀) button during playback.

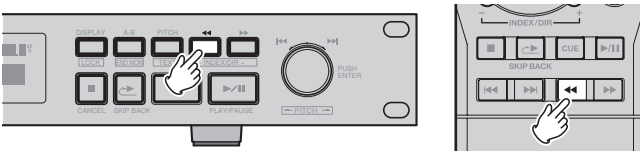

- The playback mode is cancelled, and the search point is reproduced repeatedly.
- Every time the **SEARCH** (◀◀) button is pressed the playback point retreats one frame.
- Playback of the track is sped up while the **SEARCH** (◀◀) button is pressed.

(9) Index Skip

An index search can be performed during the play of a track whose index has been recorded.

This function is useful for starting play at a specific location of a long track. It returns play to a previous index which is equivalent to the number of times the INDEX - button on the unit or IR control was pressed; alternatively, it advances play to a subsequent index which is equivalent to the number of times the INDEX + button on the unit or IR control was pressed.

If the index skip function is operated for a CD with no indexes recorded, the "No Index" message appears on the main display, and play returns to the start of the track now playing.

NOTE:

- The index skip function cannot be used for discs recorded with audio files. In that instance, the index button navigate directories.

(10) Direct Jump

Select the number of the track to be played directly during the stop mode by pressing the numeric buttons (0 to 9) on the remote control unit.

To select track number 10 or above, use the numeric buttons to select the higher digit first and then select the lower digit. The operation after the number of the track is selected depends on the start mode settings.

Example: To play track 12

1. Set the start mode to "Play".
2. Press the "1" numeric button.

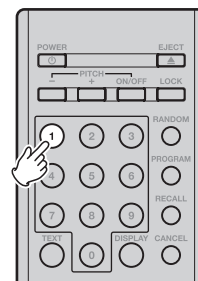

3. Within 1 second, press the "2" numeric button.



3. DEVICE OPERATION

ADVANCED CD PLAYBACK

(1) Repeating playback of a desired interval

(Single track repeat)

1. In the Preset menu, set the finish mode to "Stop", "Next" or "Recue". (See page 22)
2. Press the **REPEAT** button on the remote control unit.

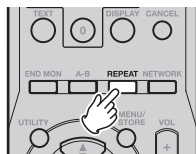

- The "REPEAT 1" indicators light on the display and the single track repeat mode is set.
3. Use the select knob to select the track to be played repeatedly.
 4. Press the **PLAY/PAUSE** button.

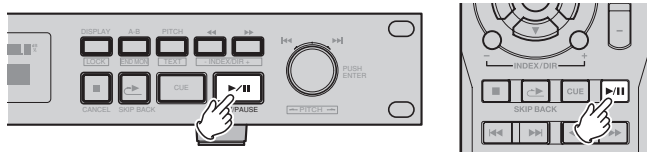

- Playback starts.
- Once the selected track ends, it is played again from the beginning.
- The single track repeat mode can also be set by pressing the **REPEAT** button during playback. The current track is played repeatedly.
- To cancel the single track repeat mode, press the **REPEAT** button repeatedly until the "REPEAT 1" indicator turns off.

(All track repeat)

1. In the Preset menu, set the finish mode to "Continuous". (See page 22)
2. Press the **REPEAT** button on the remote control unit.

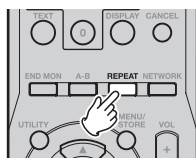

- The "REPEAT" indicators light on the display and the all track repeat mode is set.

3. Press the **PLAY/PAUSE** button.

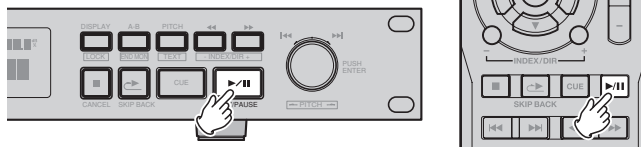

- The disc is played repeatedly.
- The all track repeat mode can also be set by pressing the **REPEAT** button during playback.
- If the **REPEAT** button is pressed during program play, the tracks are played repeatedly in the programmed order.
- To cancel the all track repeat mode, press the **REPEAT** button repeatedly until the "REPEAT" indicator turns off.

(2) Repeating playback a specific section within a track

(A-B repeat)

1. During playback, press the **A-B** button at the point where you want to start repeated playback (A point).

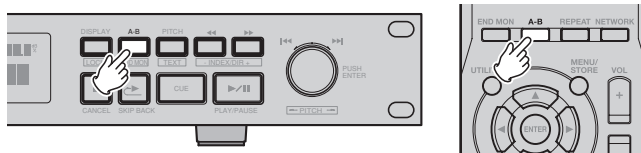

- The "A-" indicator flashes on the display.
2. Press the **A-B** button again at the point where you want to end repeated playback (B point).
 - The "A-B" indicator stops flashing (remaining lit), and the A-B section begins playing repeatedly.
 - If no B point is set before the current track ends, the end of the track is set as the B point.
 3. To cancel A-B repeat playback, press the **A-B** button again.

NOTE:

- The A-B points must be separated by at least 1 seconds time to work.

(3) Playing specific tracks in a specific order (Program play)

With this function, you can choose any of the tracks on the disc and program them to play in any order. Up to 99 tracks can be programmed.

Creating the program

1. Press the **PROGRAM** button on the remote control unit.

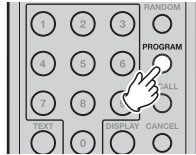

- "PGM" indicator flashes, and "P0!" appears on the display.
2. Press the **◀** or the **▶** button on the remote control unit to select the first track of the program.
 3. Press the **ENTER** button on the remote control unit to select the track.

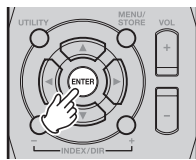

- Skip to the next desired track and press the **ENTER** button again.
 - Repeat steps 2 and 3 to program the tracks in the desired order.
4. Press the **PROGRAM** button to exit the program input mode.
- "PGM" indicator lights, and the DN-C640 is ready to play your program.

Editing the program

1. Press the **RECALL** button on the remote control unit while the "PXX" is displayed...

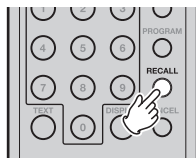

2. Press the **UP** or the **DOWN** button on the remote control unit to select the program number you want to edit.

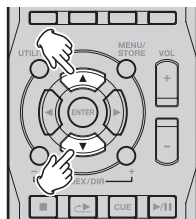

3. Press the **◀** or the **▶** button on the remote control unit to select the track of the program number.
4. Press the **CANCEL** button on the remote control unit to delete a track in the program.

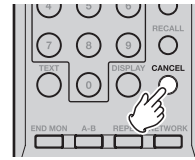

5. Press the **ENTER** button on the remote control unit to add a track.

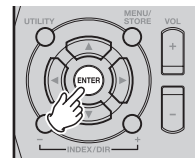

- To enter the next track, press the **ENTER** button again.
 - Repeat steps 2 and 3 to program the tracks in the desired order.
6. Press the **PROGRAM** button to exit the program edit mode.

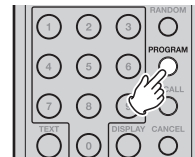

- "PGM" indicator lights, and the DN-C640 is ready to play your program.

Playing the programs

1. Press the **PLAY/PAUSE** button.

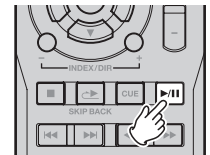
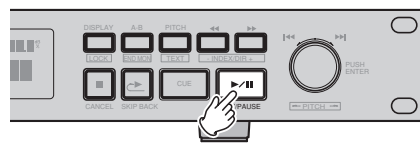

- Program play starts.

Exit the program mode

1. Press the **PROGRAM** button.
- "PGM" indicator turns off.
 - The program is also cleared when the **EJECT** button is pressed.

3. DEVICE OPERATION

(4) Pitch Control

Pitch Control allows the playback of audio at faster (+) or slower speeds(-).

1. Turning PITCH CONTROL On and OFF

Press the **PITCH** button

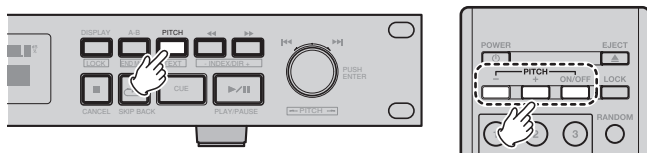

- The **PITCH** button lights up orange indicating PITCH CONTROL is ON.
- The play speed increases or decreases depending on the pitch control setting as indicated in the display.
- Press the **PITCH** button again to turn PITCH CONTROL Off.
- The **PITCH** button light turns off.

2. Adjusting the PITCH CONTROL speed

With the unit in SHIFT mode, turn the **jog wheel** counterclockwise ← to reduce the Pitch and speed or turn the **jog wheel** clockwise → to increase the Pitch and speed.

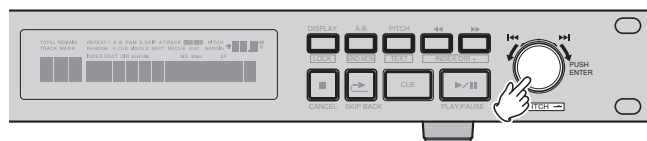

(5) Skip Back

SKIP BACK is a feature that allows instant replay of the currently playing track. When the **SKIP BACK** button on the unit or **SKIP BACK** button on the remote control unit is pressed during playback, play will skip back by the number of seconds set in the PRESET MENU and playback will resume from that point.

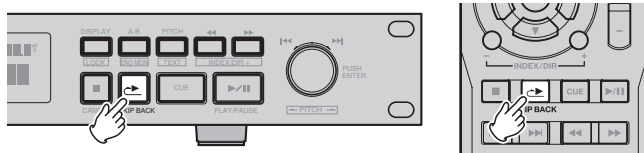

- Factory default SKIP BACK time is 10 seconds.
- For details on how to set the SKIP BACK time (See Page 23.)

(6) End Monitor

END MONITOR is a feature that plays back the final seconds of the current track. If the Finish Mode is set to "Continuous" in the preset menu, the DN-C640 plays back the last track of the current disc. To use this feature, with the unit in SHIFT mode, press the **A-B/END MON** button during in CUE mode on the device or remote control unit and the unit will start playback from the position before the end of the current track as set in the PRESET MENU.

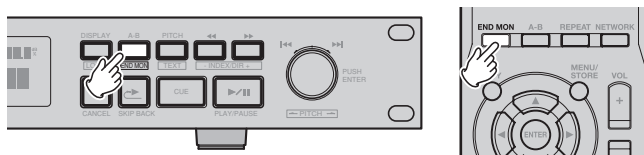







- Factory default END MONITOR time is 10 seconds.
- For details on how to set the END MONITOR time (See Page 23.)

PLAYING AUDIO FILES

In addition to standard CD-DA discs, the DN-C640 can read audio files from many different types of Data discs. For a list of compatible compressed and uncompressed audio files, see following section: Audio File Format Specifications.

■ Supported data discs

Compact Disc Recordable (CD-R)	
Compact Disc ReWritable (CD-RW)	
Digital Versatile Disk Recordable (DVD-R)	
Digital Versatile Disk ReWritable (DVD-RW)	
DVD plus R (DVD+R)	
DVD plus RW (DVD+RW)	

NOTE:

- The DN-C640 supports following file system for the data discs.
ISO9660 Level1 and Level2, Joliet, UDF version 1.50 and 2.00
- The DN-C640 cannot read unfinalized CD-R disc.
- The DN-C640 can only read the 1st session of a multi-session disc.
- There are the following conditions in the data discs that can be read.
 - Maximum number of directories: 254
 - Maximum number of files: 999
If there are more than 1,000 files, only the first 999 files are played.
 - Folder layers: 8 layers, including root
- The DN-C640 does not support two byte character sets.

■ Audio file format specifications

The DN-C640 supports PCM, MP3, MP2 and WMA audio formats.

	File Extension	System	Sample Rate	Bit Rate	Resolution
PCM	wav	16-Bit Linear PCM	48kHz, 44.1kHz, 32kHz	–	16-bit
		24-Bit Linear PCM	48kHz, 44.1kHz, 32kHz	–	24-bit
MP2	mpg	ISO/IEC11172-3 MPEG1- L2	48kHz, 44.1kHz, 32kHz	64 kbps – 384 kbps	16-bit
		ISO/IEC13818-3 MPEG2- L2	24kHz, 22.05kHz, 16kHz	32 kbps – 128 kbps	16-bit
MP3	mp3	ISO/IEC11172-3 MPEG1- L3	48kHz, 44.1kHz, 32kHz	32 kbps – 320 kbps	16-bit
		ISO/IEC13818-3 MPEG2- L3	24kHz, 22.05kHz, 16kHz	8 kbps – 160 kbps	16-bit
WMA	.wma	Windows Media Audio	48kHz, 44.1kHz	64 kbps – 192 kbps	16-bit
			32kHz	32 kbps – 48 kbps	16-bit

3. DEVICE OPERATION

■ Functions not supported by playing audio file

The following functions are not supported when the DN-C640 encounters discs recorded with these types of audio files.

- Index skip function is not available.
- While half-sample rate audio file, MPEG1-L2 (24kHz, 22.05kHz, 16kHz) and MPEG2-L3 (24kHz, 22.05kHz, 16kHz) are playable; signal to the digital outputs is not available if the Digital FS is set to "Auto" mode in the preset menu.

■ Handled audio files as "track" and playing audio file

A directory (also called a "folder") is a hierarchical level on disc media or the network drive.

After loading a data disc and searching all audio files, the DN-C640 assigns each audio file a track number.

Only the files within the selected directory will be the target of your operations, and functions such as program playback and repeat playback will all occur within the same directory.

For example in the illustration below, at first each audio file is assigned a track number. Directory-AAA, directory-BBB and directory-DDD contain audio files and can be selected for operations, but directory-CCC is excluded from operations.

If directory-AAA is selected, CD operations such as program playback are effective only to audio files of directory-AAA, it means aaa001.mp3/track# 003 and bbb001.mp3/track# 004 are effective for operation.

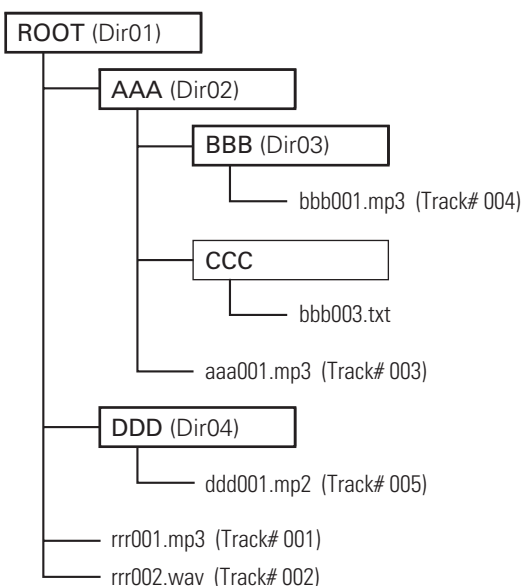

■ Displays information

When a data disc is inserted into the DN-C640, various kind of information are displayed on the 13-digit alphanumeric part of the display unit.

When in play, pause, search, end mon. or cue state, the following information is displayed in order by pressing the **DISPLAY/LOCK** button.

- Elapsed time
↓
- Remaining time
↓
- File name
↓
- File information
↓ : sample frequency, bit rate or resolution, and file format (PCM, MP2, MP3, WMA)
- Recorded date
↓ : year, month and day. [MMDD YYYY]
- Recorded time
↓ : hour, minute and second. [HH:mm:SS]
- Channel
↓ : "Stereo" or "Mono"

■ Text information

When a data disc with MP3 files, is inserted into the DN-C640, in addition to above information various kind of text information are displayed on the 13-digit alphanumeric part of the display unit. This information is recorded in a MP3 file as ID3 tag.

When in play, pause, search, end mon. or cue state, the following information is displayed in order by pressing the **PITCH/TEXT** button with the unit in SHIFT mode.

- [Above information]
↓
- Title
↓
- Artist
↓
- Album

NOTE:

- Only standard ID3 information that has been accurately recorded in the file will be displayed.

(1) Playing audio files on a disc

1. Load a disc containing audio files.

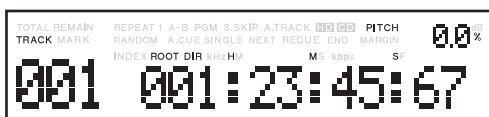

- The display will change to "Loading.". When the contents of the disc have been read, the total number of tracks will be displayed.
2. Turn the **jog wheel** to select a file you want to listen to.
 - The file name scrolls and back to the number of track on the display.
 3. Press the **PLAY/PAUSE** button.

**(Directory skip)**

1. In shift mode, press the **INDEX/DIR +/-** button to select a folder.
 - The display will indicate each name of all folders including sub-folders.
2. Press the **PLAY/PAUSE** button.
 - Playback will be started from the top file within the selected folder.

(2) Advanced music files playback

The following "Advanced CD playback" functions are possible with audio files on a disc in the same way as a standard CD-DA disc.

See page 14-16 for detail of an operation.

- **Single track repeat**
- **All track repeat**
- **A-B repeat**
- **Program play**
- **Pitch control**
- **Skip back**
- **End monitor**

3. DEVICE OPERATION

PRESET FUNCTIONS AND OPERATIONS

(1) Changing the PRESETS

[Using the front panel]

1. With the unit in stop mode, press the **MENU/STORE** button.



The last active preset item appears on the display.

2. Turn the **jog wheel** to select the preset item you wish to modify.
3. Press the **jog wheel** to confirm your selection.
Preset setting data appears on the display. You will now be able to edit the preset item.
For details of each preset item, see page 21.
4. Turn the **jog wheel** to adjust the parameters for that item.
Press the **jog wheel** to confirm your setting/action.
Repeat steps 2-4 as needed.
5. Press the **MENU/STORE** button to save changes or **STOP/CANCEL** button to cancel all changes and return to stop mode.

[Using the remote control unit]

1. With the unit in stop mode, press the **MENU/STORE** button.
The last active preset item appears on the display.

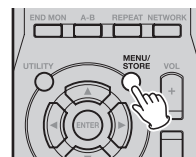

2. Press the **▲** button or the **▼** button to select the preset item you wish to modify.
3. Press the **ENTER** button to confirm your selection.
Preset setting data appears on the display. You will now be able to edit the preset item.
For details of each preset item, see page 21.

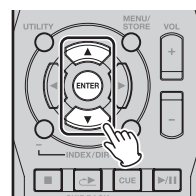

4. Press the **▲** button or the **▼** button to adjust the parameters for that item.
Press the **ENTER** button to confirm your setting/action.
Repeat steps 2-4 as needed.
5. Press the **MENU/STORE** button to save changes or **STOP** button to cancel all changes and return to stop mode.

(2) Table of Preset Items and Default settings

No (Order)	Display (Preset item)	Selection Range	Default	Reference
1.	Finish Mode	Stop /Next /Recue /Continuous	Continuous	Page 22
2.	Power On	Play /Stop	Stop	Page 22
3.	Start Mode	Play /Stop /Cue	CUE	Page 22
4.	Cue Mode	Recue /Next	Recue	Page 22
5.	Auto Cue	Off /-48dB /-42dB /-36dB	Off	Page 22
6.	Fade In	Off /0.5sec - 10.0sec (0.5second steps)	Off	Page 23
7.	Fade Out	Off /0.5sec - 10.0sec (0.5second steps)	Off	Page 23
8.	Skip Back	1.0 – 30.0 sec (0.5 second steps)	10.0	Page 23
9.	End Monitor	5 /10 /15 /20 /25 /30 /35 sec	10	Page 23
10.	EndOfMessage	Off /0 /5 /10 /15 /20 /30 /60 sec	10	Page 23
11.	NextTrReserve	On /Off	On	Page 23
12.	Fader Start	Play /Play-Pause	Play-Pause	Page 24
13.	Index Tally	Index2 /Index3	Index2	Page 24
14.	Mono	On /Off	Off	Page 24
15.	Play List	On /Off	Off	Page 24
16.	Auto Sleep	OFF /30sec /10 min /20 min /30min	30 min	Page 25
17.	Eject lock	On /Off	On	Page 25
18.	Digital Out	Broadcast /Consumer	Broadcast	Page 25
19.	Digital FS	Auto /32kHz /44.1kHz /48kHz	Auto	Page 25
20.	Time Zone	Offset -12h to +14h	Offset 0h	Page 25
21.	Machine Name	(Up to 12 digits using 0 – 9, A – Z, a – z)	DNC640A00000	Page 34
22.	IP Address	Auto/ 000 000 000 000 – 255 255 255 255	Auto	Page 34
23.	Subnet Mask	000 000 000 000 – 255 255 255 255	(255 255 255 000)	Page 34
24.	Gateway	Disable/ 000 000 000 000 – 255 255 255 255	(Disable)	Page 34
25.	DNS Server	Disable/ 000 000 000 000 – 255 255 255 255	(Disable)	Page 34
26.	Password	None or Up to 12 digits using 0 – 9, A – Z, a – z	None	Page 34
27.	Default	–	–	Page 25

NOTE:

- If the IP Address is set to "Auto", Subnet Mask, Gateway and DNS Server are not displayed in a preset menu.

3. DEVICE OPERATION

(3) Detailed description of the Preset items

1. **Finish mode** (Finish Mode)

This feature allows you to decide what the DN-C640 will do after completing the playback of a track or file.

Set value	Description
Stop	Unit returns to stop mode after the track has played
Next	Unit advances to the next track and waits in Cue Mode
Recue	Unit returns to the beginning of the current track and waits in Cue Mode.
Continuous (default)	Unit plays the next track after finishing the previous track

2. **Power on playback** (Power On)

This feature allows you to decide the status of the unit after the TOC has been read or the DIR structure has been identified.

Set value	Description
Play	Unit starts to play after boot procedure is completed
Stop (default)	Unit sits in stop mode after boot procedure is completed

3. **Start mode** (Start Mode)

This feature allows you to decide what the DN-C640 will do after a track is selected with the track search operation.

Set value	Processing	
	Inserting a new disc	Switching tracks or index points
Play	Unit starts playback at the first track of the disc	Unit starts to play the desired track or index or file
Cue (default)	Unit cues to the first track of the disc	Unit Cues to the selected track or index or file
Stop	Unit sits in stop mode	Unit Cues to the selected track or index or file

4. **Cue mode** (Cue Mode)

This feature allows you to decide what the DN-C640 will do when the CUE button is pressed.

Set value	Processing
Recue (default)	Unit returns to the previously cued start position of the currently playing file
Next	Unit cues to the next track

5. **Auto Cue** (Auto Cue)

This feature allows you to decide at what level of music the DN-C640's Auto Cue feature will detect.

Set value	Processing	
	Auto Cue	Detecting level is less than
Off (default)	Off	—
-48dB	On	-48dB
-42dB	On	-42dB
-36dB	On	-36dB

NOTE:

- If an audio signal isn't detected within the maximum period of time (20 seconds) then the DN-C640 will most likely Cue to the beginning of index 01.

6. **Fade in time** (Fade In)

This feature allows you to adjust the length of time for the DN-C640's Fade In feature

Set value	Processing	
	Fade in	Fade in time
Off (default)	Off	---
0.5sec – 10.0sec (0.5second step)	On	0.5second – 10.0seconds

7. **Fade out time** (Fade Out)

This feature allows you to adjust the length of time for the DN-C640's Fade Out feature.

Set value	Processing	
	Fade out	Fade out time
Off (default)	Off	---
0.5sec – 10.0sec (0.5second step)	On	0.5second – 10.0seconds

8. **Skip back time** (Skip Back)

This feature allows you to set the amount of time that the DN-C640 will instantly replay when SKIP BACK is pressed on the unit or IR control.

Set value	Processing	
	Skip Back time	
1.0sec – 30.0sec (Default 10.0sec) (0.5second step)	1.0second – 30.0seconds	

9. **End monitor time** (End Monitor)

This feature allows you to set the amount of time at the end of the track that the DN-C640 will play when the END MON button is pressed on the unit or IR control while in standby.

In the MP3 play mode, the time of monitor may not be correctly.

Set value	Processing	
	End Monitor time	
5sec – 35sec (Default 10sec) (5seconds step)	5seconds – 35seconds	

10. **End of message time** (EndOfMessage)

This feature allows you to set the amount of time at the end of the track where the End of Message will be displayed. When less than the user selected time is left at the end of the currently playing track, the time display will begin to flash until the track has completed.

Set value	Processing	
	End of Message	End of Message time
Off	Off	---
0/ 5 /10 /15 /20 /30 /60sec (Default 10sec)	On	0/ 5 /10 /15 /20 /30 /60seconds

11. **Next track reserve** (NextTrReserve)

This feature allows you to decide what the DN-C640 will do at the end of a track

Finish mode setting is "Stop"	
Set value	Processing at the end of track
On (default)	<i>(Reserved a next track):</i> Cue at the playback starting position of index 01 of reserved track <i>(Not reserved a next track):</i> Stop
Off	Stop

3. DEVICE OPERATION

Finish mode setting is "Next"	
Set value	Processing at the end of track
On (default)	<i>(Reserved a next track):</i> Cue at the playback starting position of index 01 of reserved track <i>(Not reserved a next track):</i> Cue at the beginning of index 01 of next track
Off	Cue at the beginning of index 01 of next track

Finish mode setting is "Recue"	
Set value	Processing at the end of track
On (default)	<i>(Reserved a next track):</i> Cue at the beginning of index 01 of reserved track <i>(Not reserved a next track):</i> Cue at the playback starting position
Off	Cue at the playback starting position

Finish mode setting is "Continuous"	
Set value	Processing at the end of track
On (default)	<i>(Reserved a next track):</i> Start playback at index 01 of reserved track. If the reserved track is next track of the current track, it will start playback at index 00. <i>(Not reserved a next track):</i> Start playback at index 00. If the current track is final track of the disc, It will stop.
Off	Start playback at index 00. If the current track is final track of the disc, It will stop.

12. Fader start mode (Fader Start)

This feature allows you to decide how the DN-C640 behaves when the Fader Start pins are short-circuited

Set value	Processing
Play	Unit starts playback when the remote fader pins (9-11) are short circuited and remains playing when the pins open
Play-Pause (default)	Unit starts playback when the remote fader pins (9-11) are short circuited and pauses playback when the pins open

13. Index tally (Index Tally)

This feature allows you to select the processing of INDEX tally pin (17) of the parallel control terminal.

Set value	Processing
Index2 (default)	Output index 2 tally signal to INDEX tally pin (17).
Index3	Output index 3 tally signal to INDEX tally pin (17).

14. Mono mode (Mono)

This feature allows you to force playback of stereo audio into a mono signal sent out both the L and R terminals

Set value	Processing
Off (default)	Output L and R original signals from the output terminals.
On	Output mixed L and R stereo signals from the output terminals.

15. Playlist playback mode (Play List)

This allows you to turn on or off the ability to play a playlist created in the Web Remote (See Page 32)

Set value	Processing
Off (default)	The playlist is ignored and normal playback is possible
On	The unit plays back according to the files designated in the playlist

16. Auto sleep mode (Auto Sleep)

You can select the behavior that the servo functions will automatically turn off if no operation is performed for set-up time while in stop, pause or cue.

When in the sleep mode, if the **PLAY/PAUSE** button is pressed, playback will be started from the beginning of the track in which the sleep mode was set. If the **CUE** button is pressed, it will standby for the beginning of the track in which the auto sleep was set.

Set value	Processing
Off	Unit never goes into sleep mode
30sec 10min 20min 30min(default)	Unit will goes into sleep mode if no servo functions occur for longer than the user-designated time

17. Eject lock mode (Eject Lock)

This feature allows you to prohibit ejecting a disc during playback

Set value	Processing
On (default)	Unit will not allow anyone to eject a disc while in the Play Mode
Off	Unit will allow a disc to be ejected while in the Play Mode

18. Digital output format (Digital Out)

This allows you to designate the Digital Output format that is sent to both the balanced and unbalanced digital output terminals.

Set value	Processing
Broadcast (default)	Unit outputs AES/EBU formatted digital audio signal to both the balanced DIGITAL OUTPUT jack and the unbalanced DIGITAL OUTPUT jack
Consumer	Unit outputs S/PDIF formatted digital audio signal to both the balanced DIGITAL OUTPUT jack and the unbalanced DIGITAL OUTPUT jack

19. Digital FS (Digital FS)

This feature allows you to set the sampling frequency of the digital audio signal that is sent out the DIGITAL AUDIO outputs.

Set value	Digital audio signal is outputted with below FS					
	FS of the source audio signal					
	16 kHz	22.05 kHz	24 kHz	32 kHz	44.1 kHz	48 kHz
Auto (default)	–	–	–	32 kHz	44.1 kHz	48 kHz
32kHz	32 kHz	32 kHz	32 kHz	32 kHz	32 kHz	32 kHz
44.1kHz	44.1 kHz	44.1 kHz	44.1 kHz	44.1 kHz	44.1 kHz	44.1 kHz
48kHz	48 kHz	48 kHz	48 kHz	48 kHz	48 kHz	48 kHz

20. Time Zone (Time Zone)

This feature allows you to select the Time zone. This setting is necessary to display the time correctly.

Value of the Time Zone should represent the differences between the UTC(GMT) and your local time.

NOTE:

- Turn the power off and on again to make the new settings effective.

Items 21-26 refer to the network operation of the unit. See page 34.

21. Machine name (Machine Name)**22. IP Address setting** (IP Address)**23. Subnet mask setting** (Subnet Mask)**24. Default Gateway setting** (Gateway)**25. DNS server setting** (DNS Server)**26. Network-Access Password setting** (Password)**27. Default** (Default)

Setting this feature allows you to reset all of the unit's preset items to their default values.

3. DEVICE OPERATION

UTILITY MENU

When you use the front panel for operation, press the **SHIFT** button in stop mode to enter shift mode (**SHIFT** button will light Amber). Then press the **MENU/STORE/UTILITY** button to access the functions of the UTILITY MENU listed in the table below. When you use the remote control unit for operation, press the **UTILITY** button to access the functions of the UTILITY MENU listed in the table below.

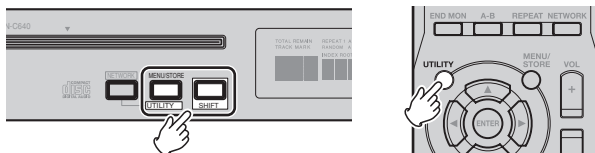

(1) Utility Menu Function Table

No (Order)	Display (Preset item)	Description	Reference
1.	Upload Disc	This feature copies all of the tracks or files on the loaded disc to the network shared folder designated in the Web Remote. All the tracks on the disc are copied into a new folder created in the shared folder. If the disc in the machine has a hierarchal folder structure, that structure is also copied to the shared drive.	Page 26
2.	Upload Track	This feature allows you to make a copy of a single selected track on the loaded disc to the shared folder. The copy of the track is made in a new folder created in the shared folder.	Page 26
3.	FW Version	Displays the units FW version	Page 27
4.	Drive Version	Displays the units CD drive version	Page 27
5.	IP Address	Displays the units IP address	Page 27

(2) Procedure for Upload Disc

[Using the front panel]

- While in stop and shift mode, press the **MENU/STORE/UTILITY** button.



- Turn the **jog wheel** until "Upload Disc" appears in the display.



- Press the **jog wheel**. The Display switches to "Upload Disc OK?" and the "OK?" flashes.
- Press the **jog wheel**. "Executing" will be displayed until Upload Disc is finished. Then "Completed" will be displayed.
- Press the **STOP/CANCEL** button to cancel.

[Using the remote control unit]

- While in stop and shift mode, press the **UTILITY** button.
- Press the **▲** button or the **▼** button until "Upload Disc" appears in the display.
- Press the **ENTER** button. The Display switches to "Upload Disc OK?" and the "OK?" flashes.
- Press the **ENTER** button. "Executing" will be displayed until Upload Disc is finished. Then "Completed" will be displayed. Press the **STOP** button to cancel.

(3) Procedure for Upload Track

[Using the front panel]

- While in stop or play-pause mode, press the **SHIFT** button to light the shift button. Then press the **MENU/STORE/UTILITY** button.
- Turn the **jog wheel** until "Upload Track" appears in the display.



- Press the **jog wheel**. The Display switches to the track number flashing.
- Turn the **jog wheel** until the track number you want to upload is flashing.
- Press the **jog wheel**. "Executing" will be displayed until Upload Track is finished. Then "Completed" will be displayed.
 - Display returns to step 4 so you can upload another track.
- Press the **STOP/CANCEL** button to cancel.

[Using the remote control unit]

- While in stop or play-pause mode, press the **UTILITY** button.
- Press the **▲** button or the **▼** button until "Upload Track" appears in the display.
- Press the **ENTER** button. The Display switches to the track number flashing.
- Press the **▲** button or the **▼** button until the track number you want to upload is flashing.
- Press the **ENTER** button. "Executing" will be displayed until Upload Track is finished. Then "Completed" will be displayed.
Display returns to step 4 so you can upload another
- Press the **STOP** button to cancel.

(4) Procedure for Displaying the Unit's F/W Version

[Using the front panel]

- While in stop and shift mode, press the **MENU/STORE/UTILITY** button.
- Turn the **jog wheel** until "FW version" appear in the display.



- Press the **jog wheel**. The Display switches to the firmware version.
- Press the **STOP/CANCEL** button to cancel.

[Using the remote control unit]

- While in stop mode, press the **UTILITY** button.
- Press the **▲** button or the **▼** button until "F/W version" appear in the display.
- Press the **ENTER** button. The Display switches to the firmware version.
- Press the **STOP** button to cancel.

(5) Procedure for Displaying the Unit's Drive Version

[Using the front panel]

- While in stop and shift mode, press the **MENU/STORE/UTILITY** button.
- Turn the **jog wheel** until "Drive version" appear in the display.

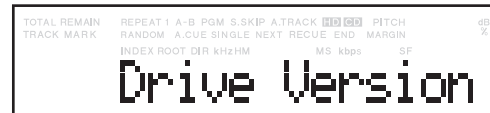

- Press the **jog wheel**. The Display switches to the firmware version.
- Press the **STOP/CANCEL** button to cancel.

[Using the remote control unit]

- While in stop mode, press the **UTILITY** button.
- Press the **▲** button or the **▼** button until "Drive Version" appear in the display.
- Press the **ENTER** button. The Display switches to the firmware version.
- Press the **STOP** button to cancel.

(6) Procedure for Displaying the Unit's IP Address

[Using the front panel]

- While in stop and shift mode, press the **MENU/STORE/UTILITY** button.
- Turn the **jog wheel** until "IP Address" appear in the display.



- Press the **jog wheel**. The display switches to the IP address.
- Press the **STOP/CANCEL** button to cancel.

[Using the remote control unit]

- While in stop mode, press the **UTILITY** button.
- Press the **▲** button or the **▼** button until "IP Address" appear in the display.
- Press the **ENTER** button. The Display switches to the IP Address.
- Press the **STOP** button to cancel.

4. NETWORK FUNCTIONALITY AND OPERATION

Network functionality and Operation

The network functionality of the Denon Professional DN-C640 allows you to play back compatible audio files from a shared network resource or drive as well as provide you with a simple web-based user interface to control the DN-C640 over your network. The DN-C640 has following functions.

1. Playing audio files from the network drive
The DN-C640 can play the audio files stored in a shared folder on a network computer.
2. Uploading audio files
The DN-C640 can make a copy of a file or files, or the entire disc to the shared folder. See Utility menu – Page 27.
3. Web remote control
The DN-C640's internal Web GUI allows any internet ready computer on the network to have full control of the DN-C640's features. All features on the front panel and in the preset menu can be controlled by the unit's web remote. Additionally, .m3u style playlists can be built, downloaded or uploaded to the device from the web remote. See Web remote – Page 30.

How to hook up the DN-C640 to your network

Connect the DN-C640 to the network using the Ethernet RJ-45 terminal (LAN) on the rear of the unit.

You can connect the DN-C640 in any of the following ways:

- Through a corporate network
- Through a home network using a router or switch
- Directly to a computer using an Ethernet cross-over cable.

The DN-C640 supports the automatic acquisition of IP addresses from a DHCP server.

More often than not, you can connect your DN-C640 to a corporate network or home network in three easy steps:

1. Before connecting the DN-C640, set the preset setting of "IP Address" to Auto (default).
It means that the DN-C640 will attempt to acquire the network settings from a DHCP server in the network.
2. Connect the DN-C640 to the network using the Ethernet RJ-45 terminal on the rear of the unit.
If you are not connected to a network, use a cross-over Ethernet cable to connect the unit directly to your computer.
3. Turn the unit on.
The DN-C640 automatically configures its network settings and communications with the network or computer without you having to do anything further.

NOTE :

- If you set the preset setting of "IP Address" to Auto, use utility menu to find the IP address of the DN-C640 that is assigned by a DHCP server automatically.
- If the DN-C640 can not find a DHCP server, when the DN-C640 is turned power on, it might take time to finish initializing.
- If you assign the network setting manually, at the first you should set the following preset setting of the DN-C640.
 - IP address
 - Subnet Mask
 - Gateway

Set "DNS Server" setting if necessary.

NOTE

If you are not familiar with the network environment where you wish to connect your DN-C640, please contact your network or IT official or administrator.

Setting up a Shared Folder on a Server or a Network Server

The DN-C640 can read and play audio files in a shared folder of a server or a network server.

1. Create a shared folder on a server.
2. Bring up the Web Remote on any network computer. See page 30.
3. Click Network settings tab.
4. Type the share name, the accessing user account and password in the textboxes of **Network Shared Drive**.
5. Click the **SAVE and RESTART** button.
6. The DN-C640 will reboot.

The screenshot displays the 'DENON Network Settings' web interface. The 'Network Shared Drive' section is highlighted with a red box. It contains the following fields and values:

- Machine Name: DNC640A00000
- Set IP Address:
 - Automatically(DHCP/AutoIP):
 - Manually:
 - IP address: 192 . 168 . 0 . 1
 - SubnetMask: 255 . 255 . 255 . 0
 - DefaultGateway:
 - DNS Server:
- Password:
- Re-Enter Password:
- MAC Address: 00-05-CD-81-00-28
- Network Shared Drive** (highlighted):
 - Drive Name: \\192.168.0.100\STREAM
 - Login User Name: DENON
 - Login Password:
 - Re-Enter Login Password:

At the bottom of the form are three buttons: **SAVE and RESTART**, **CANCEL**, and **DEFAULT**.

For detail of the Web remote, see page 30.

5. CONTROL FEATURES

WEB REMOTE

The application “Web Remote” allows you to control the unit and configure settings from your computer. The DN-C640 supports common web browsing software applications.

To connect to the DN-C640's web remote, start up your web browser and specify the DN-C640's IP address, for example, “http://192.168.0.1/” to open the web control screen.

(1) Password screen

Open the web control screen and then type the password in the password window to gain access to the web remote. The password window appears only when a password has been set in the preset menu. If no password has been set in the preset menu then connecting to the web browser skips the password screen and connects directly to the Control window.

1. Type the password in the PASSWORD text box.
2. Click **GO** button.

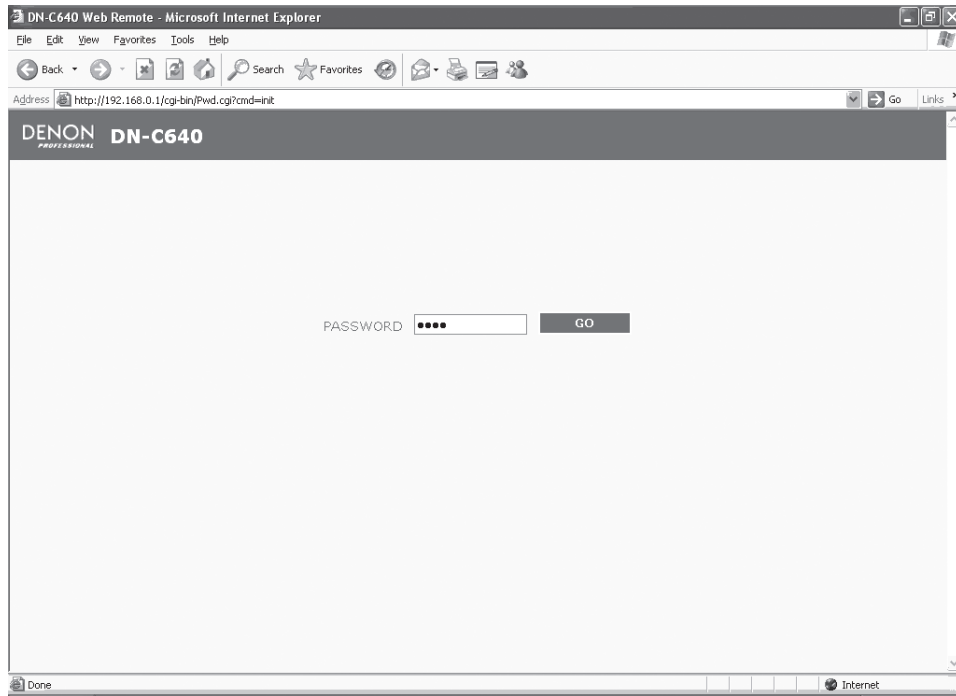

(2) Control screen

The Web remote screen contains four tabs; Control, Program, General Settings, and Network Settings. The Control window contains controls of the DN-C640.

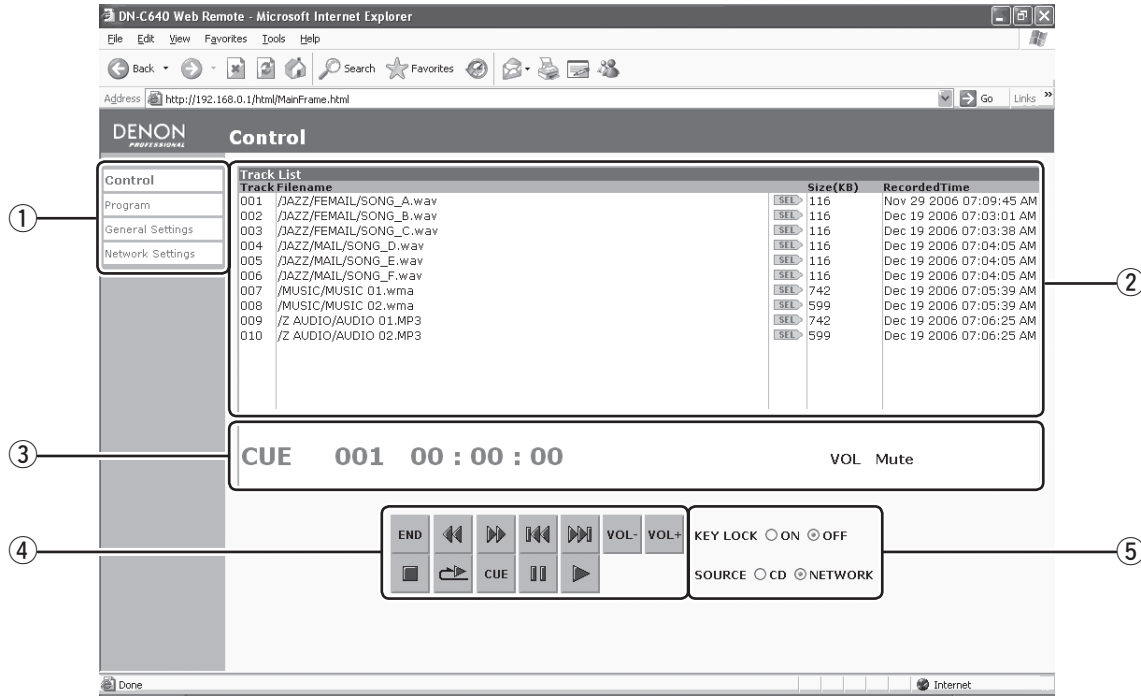

① Screen select tabs:

Control tab: This screen allows you to control the DN-C640 in the same way as operating the front panel, and displays the track or audio file information of disc / shared network drive, and the status of the DN-C640.

Program tab: The **Program** screen allows you to create, upload, and download .m3u type playlists.

General Setting tab: The **General Setting** screen allows you to modify many of the settings that are in the Preset Menu.

Network Setting tab: The **Network Setting** screen allows you to modify the network settings that are in the Preset menu. This is also where you can designate the network shared folder that the DN-C640 connects to in NETWORK mode.

② Track List:

Track number, file name and track time are displayed in this area. In case of CD-DA "track" + [track number] is displayed as the file name unless the disc is equipped with CD-Text where the file name will appear in place of "track" + [track number].

③ Status indicator:

The status of the DN-C640 and the playback volume level are displayed in this area.

If the machine is in:

stop:	STOP	VOL +6dB
play:	PLAY 003 00:00:00	VOL 0dB
pause:	PAUSE 001 00:00:01	VOL 4dB
cue:	CUE 001 00:00:00	VOL -10dB
end monitor:	E.MON 010 00:00:01	VOL -30dB
search:	SEARCH 001 00:00:00	VOL -30dB
no disc:	NO DISC	VOL -40dB
sleep:	SLEEP	VOL -60dB
the other case:	OTHERS	VOL Mute

④ Control icon:

These buttons allow you to operate the DN-C640 in same way as pressing front panel buttons or IR controller buttons.

⑤ KEY LOCK switch and SOURCE switch:

KEY LOCK switch: Locks the front panel buttons
SOURCE switch: Selects the source for playback

5. CONTROL FEATURES

(3) Program screen

The Program screen allows you to make a program play settings, turn the program mode on or off, and create a playlist. It also allows you to download created playlists to your computer for future use as well as upload previously constructed playlists to the device.

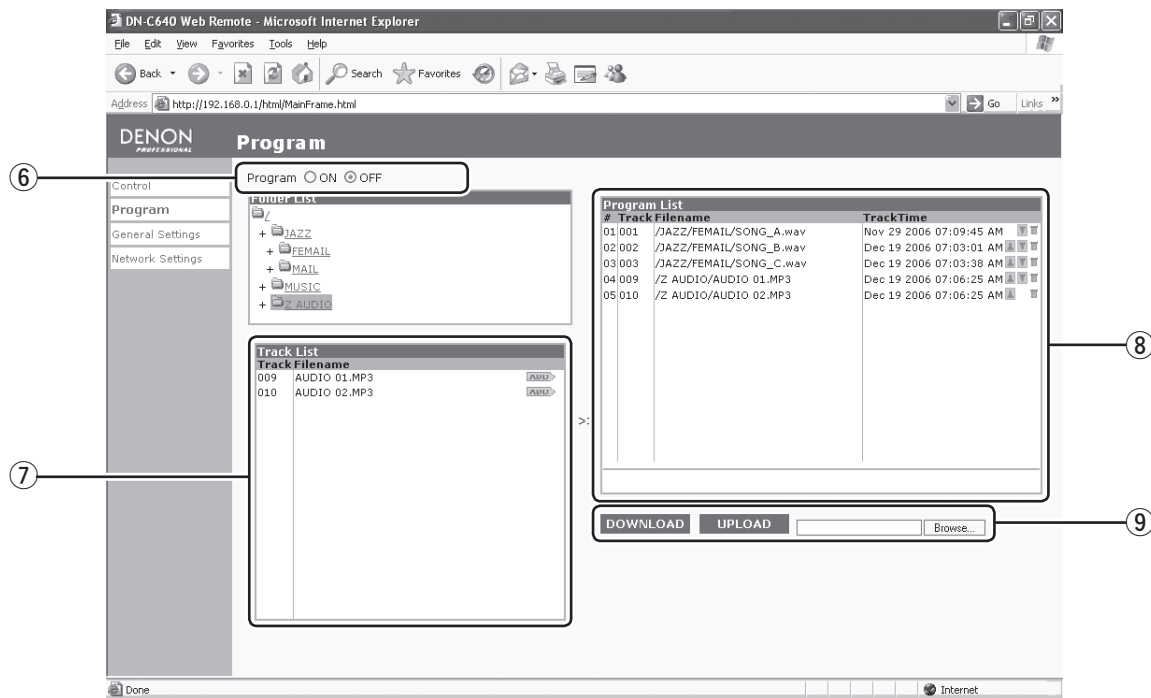

⑥ Program switch:

Select ON to enter program play mode.

⑦ Track List:

Track number and file name are displayed in this area. If you want to add any track to the program list (playlist), click the **ADD** button on the right side the filename.

⑧ Program List (Playlist):

The order of program play, track number and track time are displayed in this area. If you wish to edit it, click any of the buttons on the right side as needed.

- ▲ (Up) button: Moves the corresponding file or track up in the playlist
- ▼ (Down) button: Moves the corresponding file or track down in the playlist
- 🗑 (Delete) button: Removes the corresponding file or track from a playlist

⑨ DOWNLOAD and UPLOAD buttons:

These allow you to download and upload a playlist for the DN-C640.

- DOWNLOAD** button: Downloads the current playlist stored in the DN-C640 to the shared folder as file "xxxxx.xxx"
- UPLOAD** button: Uploads a playlist stored in the shared folder named "xxxxx.xxx" to the DN-C640.

(4) General settings screen

The General settings screen allows you to modify many of the playback features found in the Preset Menu of the device. The function of all of the settings are the same as found in the Preset Menu. See Page 21.

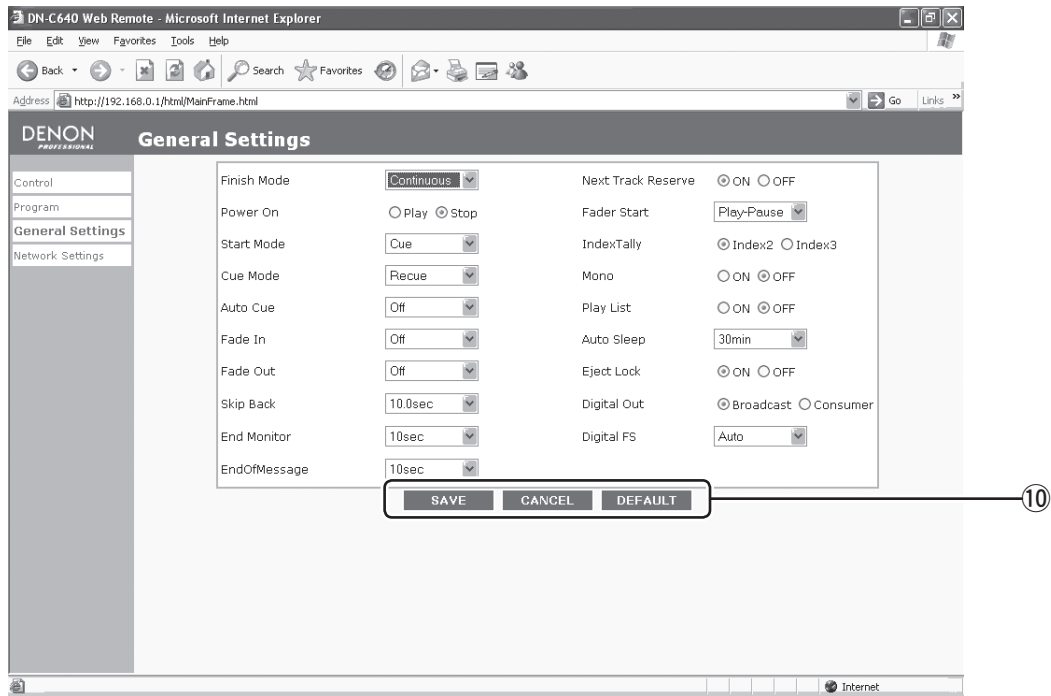
**⑩ SAVE button, CANCEL button and DEFAULT buttons:**

- SAVE** button: Stores all changes made to items in this window.
- CANCEL** button: Cancels all changes made to items in this window and then displays the current settings.
- DEFAULT** button: Resets all items in this window to the factory default value.

5. CONTROL FEATURES

(5) Network settings screen

The Network settings screen allows you to modify the network settings of the DN-C640 as well as designate the location and sign-in information of the desired network shared folder. The function of all of the settings are the same as found in the Preset Menu.

See page 20 about an operation of a preset menu. About detailed explanation of each network setting item, see below.

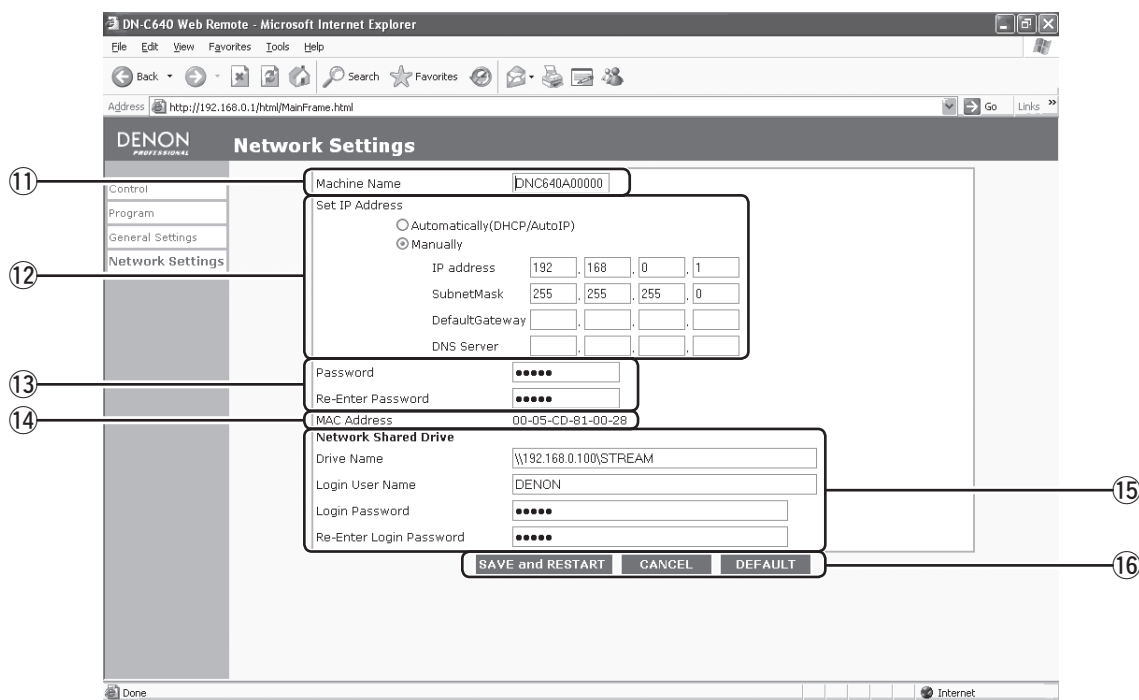

⑪ Machine Name text box:

When in uploading audio files by an upload function, the DN-C640 upload audio files in a folder of this name under the shared folder.

⑫ Set IP Address control:

You must set the DN-C640's network address here.

If you connect the DN-C640 to the server using DHCP, check the Automatically(DHCP/Auto IP) radio button. The value of IP address, Subnet Mask, Default Gateway and DNS Server text boxes disappear.

If you assign the network settings manually, check the "Manually" radio button and type the your desired IP address, Subnet Mask, Default Gateway and DNS Server text boxes.

⑬ Password textbox:

If you want to have password security for access to the web remote, type password into Password textbox and Re-Enter Password textbox.

⑭ MAC Address indicator:

Displays the MAC address of the DN-C640.

⑮ Network Shared Drive control:

You must set the shared drive (folder) information here.

Drive Name textbox: type the share name of the shared folder with full-pass. (Share name is generally same as a folder name.)

Login User Name textbox: type a user account for accessing the shared folder.

Login Password textbox: type a user account password for accessing the shared folder. Same password should be typed into Re-Enter Login Password textbox.

16 Save and Restart, Cancel and Default buttons:

SAVE and RESTART button: If any changes have been made to the network settings screen and need to be saved, press the SAVE and RESTART button. This will store the changes made and forces the DN-C640 to reboot. If the SAVE and RESTART button is pressed, a confirmation screen will appear.



If ok, click OK button and then the DN-C640 will shut down, and reboot. While rebooting, the following is displayed on the screen.

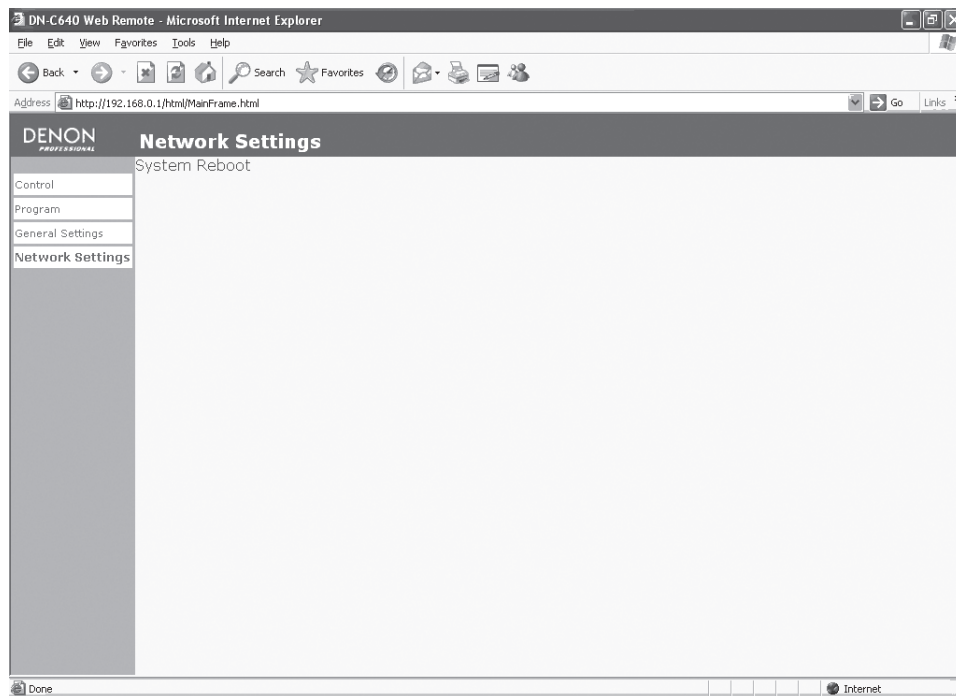

CANCEL button:

Cancels all changes made to the network settings in this window and then display current settings.

DEFAULT button:

Resets all network settings in this window to the factory default value. Then click **SAVE and RESTART** button and reboot the DN-C640 to confirm the settings.

5. CONTROL FEATURES

RS-232C CONTROL

Connect a male (D-Sub 9 Pin) to female (D-Sub 9 Pin) straight cable for RS-232C external control by host equipment.

- The RS-232C host can control functions of the DN-C640 externally
- The DN-C640 automatically transmits status data when status is changed.
- The DN-C640 will respond to status requests by transmitting the associated status data RS-232C specifications:

(1) Interface Condition

- Applicable connector : 9-pin D-sub (male)
- Baud rate : 9600 bps
- Data Bit : 8bit
- Parity : None
- Stop bit : 1bit
- Flow control : None
- Pin layout

RS-232C

Pin No	Signal Name
1	Ground
6	NC
2	TxD
7	NC
3	RxD
8	NC
4	NC
9	NC
5	S. Ground

(2) Control command codes

The control command packets have a data length of 7 bytes or more. ASCII codes from 0x00 to 0x7F are used to receive serial data. At the transmission end, take steps to convert the ASCII codes into HEX data to set the data in the data packets. CR (0x0D) is added as the data packet delimiter.

Example: Control command code for number 5 (ASCII code @02005CR)

When transmitting commands consecutively, put more than 100ms blank between commands.

@	0	2	0	0	5	CR
0 × 40	0 × 30	0 × 32	0 × 30	0 × 30	0 × 35	0 × 0d

(3) Status Request and Status Information codes

The status data packets have a data length of 7 bytes or more.

ASCII codes from 0 × 00 to 0 × 7f are used to transmit serial data. For this reason, the ASCII codes are converted into HEX data before the data is set in the data packets and transmitted. CR (0 × 0d) is added as the data packet delimiter.

Example: Status Information code "Disc In" (ASCII code @0 CDCI CR)

@	0	C	D	C	I	CR
0 × 40	0 × 30	0 × 43	0 × 44	0 × 43	0 × 49	0 × 0d

(4) Table of Control command codes

Code	Command	Comment
"@02000"+CR	0	
"@02001"+CR	1	
"@02002"+CR	2	
"@02003"+CR	3	
"@02004"+CR	4	
"@02005"+CR	5	
"@02006"+CR	6	
"@02007"+CR	7	
"@02008"+CR	8	
"@02009"+CR	9	
"@02011"+CR	DISPLAY	
"@02012"+CR	Power Standby	
"@020PW"+CR	Power On	
"@02016"+CR	Volume Up	
"@02017"+CR	Volume Down	
"@02028ON"+CR	RANDOM ON	
"@02028OF"+CR	RANDOM OFF	
"@02029ON"+CR	REPEAT ON	
"@02029OF"+CR	REPEAT OFF	
"@02032"+CR	Track Jump ►►	
"@02033"+CR	Track Jump ◄◄	
"@02034"+CR	INDEX +	
"@02035"+CR	INDEX -	
"@02037ON"+CR	PITCH ON	
"@02037OF"+CR	PITCH OFF	
"@02038"+CR	PITCH +	
"@02039"+CR	PITCH -	
"@02045"+CR	EJECT	
"@02048"+CR	PAUSE	
"@02050"+CR	F. REVERSE	
"@02052"+CR	F. FORWARD	
"@02053"+CR	PLAY	
"@02054"+CR	STOP	
"@02059"+CR	A-B	
"@020CU"+CR	CUE	
"@020EM"+CR	END MON	
"@020SB"+CR	SKIP BACK	
"@020NWON"+CR	NETWORK ON	
"@020NWOF"+CR	NETWORK OFF	
"@020UPALL"+CR	UPLOAD DISC	
"@020UPXXX"+CR	UPLOAD TRACKXXX	XXX is Track Number
"@020KL"+CR	Lock Panel's Key	

5. CONTROL FEATURES

Code	Command	Comment
"@020KU"+CR	Unlock Panel's Key	
"@020DJXXXXXXXXXXXXX"+CR	Direct Jump XXXXXXXXXXXX=ttthhmmssff	ttt is Track Number
"@0FMST"+CR	Finish Mode - Stop	
"@0FMNT"+CR	Finish Mode -Next	
"@0FMRC"+CR	Finish Mode - Recue	
"@0FMCT"+CR	Finish Mode - Continuous	
"@0POPL"+CR	Power On - Play	
"@0POST"+CR	Power On - Stop	
"@0SAPL"+CR	Start Mode Play	
"@0SACU"+CR	Start Mode Cue	
"@0SAST"+CR	Start Mode Stop	
"@0CURC"+CR	Cue Mode Recue	
"@0CUNT"+CR	Cue Mode Next	
"@0AC00"+CR	Auto Cue - OFF	
"@0AC48"+CR	Auto Cue -- 48dB	
"@0AC42"+CR	Auto Cue -- 42dB	
"@0AC36"+CR	Auto Cue -- 36dB	
"@0FIXX"+CR	Fade In - 00:OFF, 005:0.5sec, 010:1.0sec, ... 100:10.0sec	
"@0FOXXX"+CR	Fade Out - 00:OFF, 005:0.5sec, 010:1.0sec, ... 100:10.0sec	
"@0SBXXX"+CR	SkipBack - 010:1.0sec, 015:1.5sec, ... 300:30.0sec	
"@0EMXX"+CR	End Mon - 05:5sec, 10:10sec, 15:15sec, ... 35:35sec	
"@0EDXX"+CR	EOM - OF:OFF, 05:5sec, 10:10sec, 15:15sec, 20:20sec, 30:30sec, 60:60sec	
"@0NRXX"+CR	Next Reserve - 00:ON, 01:OFF	
"@0FDPL"+CR	Fader Start -Play	
"@0FDPU"+CR	Fader Start -PlayPause	
"@0IT12"+CR	Index Tally Index2	
"@0IT13"+CR	Index Tally Index3	
"@0MOXX"+CR	Mono - 00:ON, 01:OFF	
"@0PLXX"+CR	PlayList - 00:ON, 01:OFF	
"@0ASXXX"+CR	Sleep-0000:OFF,0030:0.5min,1000:10min, 2000:20min, 3000:30min	
"@0ELXX"+CR	Eject Lock - 00:ON, 01:OFF	
"@0DOBC"+CR	Digital Out - Broadcast	
"@0DOCS"+CR	Digital Out - Consumer	
"@0DFXX"+CR	Digital FS - AT:Auto, 32:32kHz, 44:44.1kHz, 48:48kHz	
"@0MNXXXXXXXXXXXXX"+CR	Machine Name - 0..9, AtoZ, atoz	Max 12 characters
"@0IPXXXXXXXXXXXXX"+CR	IP Address - 0..9, AUTO00000000:Auto	
"@0SMXXXXXXXXXXXXX"+CR	Subnet Mask - 0..9	
"@0GWXXXXXXXXXXXXX"+CR	Gateway - 0..9, DISABLE00000:Disable	
"@0DNXXXXXXXXXXXXX"+CR	DNS Address - 0..9, DISABLE00000:Disable	
"@0PDXXXXXXXXXXXXX"+CR	Password - 0..9, A to Z, a to z	Max 12 characters
"@0DEFL"+CR	General Preset Default	
"@0DENW"+CR	Network Preset Default	

(5) Table of Status Request and Status information codes

When a Status Request Command from the host is received by the DN-C640, the DN-C640 sends the Status Information to the host. When the DN-C640 changes status, the DN-C640 automatically sends Status Information to the host.

Mode	Request Code	Status	
Power Mode	"@0?PW"+CR		On "@0PW00"+CR
			Standby "@0PW01"+CR
			Off -
Disc	"@0?CD"+CR		No Disc "@0CDNC"+CR
			Loading "@0CDRE"+CR
			Disc In "@0CDCI"+CR
			Network "@0CDNW"+CR
			Executing "@0CDEX"+CR
			DiscError(Unformat) "@0CDCE"+CR
Status	"@0?ST"+CR	Stop	Stop "@0STST"+CR
			Cue "@0STCU"+CR
			Sleep "@0STSL"+CR
		Play	Playback "@0STPL"+CR
			Playback Pause "@0STPP"+CR
			FF "@0STFF"+CR
			RWD "@0STRW"+CR
			END MON "@0STEM"+CR
		Other	Ulility / Preset "@0STED"+CR
			Operation Error "@0STER"+CR
Time Mode	"@0?TM"+CR	Time Mode	TotalDiscTime "@0TMTD"+CR
			Track Elapse Time "@0TMTT"+CR
			Track Remain Time "@0TMTR"+CR
			File Name "@0TMFN"+CR
			File Information "@0TMFI"+CR
			Recorded Date "@0TMRD"+CR
			Recorded Time "@0TMRT"+CR
			Recorded Channel "@0TMCH"+CR
Track Number	"@0?TR"+CR	Track Number	"@0TRXXX"+CR
Display Time	"@0?TI"+CR	Time	"@0Tlhhmmssff"+CR
Volume	"@0?VM"+CR	Volume	"@0VMXXX"+CR
Pitch	"@0?PT"+CR	Pitch	"@0PTXXX"+CR
Text Title	"@0?T1"+CR	Text Title	"@0T1XXX..." +CR *1
Text Artist	"@0?T2"+CR	Text Artist	"@0T2XXX..." +CR *1
Text Album	"@0?T3"+CR	Text Album	"@0T3XXX..." +CR *1
POS Code	"@0?C1"+CR	POS Code	"@C1XXXXXXXXXXXXX"+CR
ISRC Code	"@0?C1"+CR	ISRC Code	"@C2XXXXXXXXXXXXX"+CR

*1: 0 to 255 digits

5. CONTROL FEATURES

Mode	Request Code	Status	
Finish Mode	"@0?FM"+CR	Stop	"@0FMST"+CR
		Next	"@0FMNT"+CR
		Recue	"@0FMRC"+CR
		Continuous	"@0FMCT"+CR
Power On	"@0?PO"+CR	Play	"@0POPL"+CR
		Stop	"@0POST"+CR
Start Mode	"@0?SA"+CR	Play	"@0SAPL"+CR
		Cue	"@0SACU"+CR
		Stop	"@0SAST"+CR
Cue Mode	"@0?CU"+CR	Recue	"@0CURC"+CR
		Next	"@0CUNT"+CR
Auto Cue	"@0?AC"+CR	Off	"@0AC00"+CR
		-48dB	"@0AC48"+CR
		-42dB	"@0AC42"+CR
		-36dB	"@0AC36"+CR
Fade In	"@0?FI"+CR	Time	"@0FIXXX"+CR
Fade Out	"@0?FO"+CR	Time	"@0FOXXX"+CR
Skip Back	"@0?SB"+CR	Time	"@0SBXXX"+CR
End Mon	"@0?EM"+CR	Time	"@0EMXX"+CR
End Of Message	"@0?ED"+CR	Time	"@0EDXX"+CR
Next Tr Reserve	"@0?NR"+CR	On	"@0NR00"+CR
		Off	"@0NR01"+CR
Fader Start	"@0?FD"+CR	Play	"@0FDPL"+CR
		PlayPause	"@0FDPU"+CR
Index Tally	"@0?IT"+CR	Index2	"@0ITI2"+CR
		Index3	"@0ITI3"+CR
Mono	"@0?MO"+CR	On	"@0MO00"+CR
		Off	"@0MO01"+CR
PlayList	"@0?PL"+CR	On	"@0PL00"+CR
		Off	"@0PL01"+CR
Sleep	"@0?AS"+CR	Time	"@0ASXXX"+CR
Eject Lock	"@0?EL"+CR	On	"@0EL00"+CR
		Off	"@0EL01"+CR
Digital Out	"@0?DO"+CR	Broadcast	"@0DOBC"+CR
		Consumer	"@0DOCS"+CR
Digital FS	"@0?DF"+CR	FS	"@0DFXX"+CR
Machine Name	"@0?MN"+CR	Name *2	"@0MNXXXXXXXXXXXX"+CR
IP address	"@0?IP"+CR	Address	"@0IPXXXXXXXXXXXX"+CR
Subnet Mask	"@0?SM"+CR	Mask Bit	"@0SMXXXXXXXXXXXX"+CR
Gateway	"@0?GW"+CR	Address	"@0GWXXXXXXXXXXXX"+CR
DNS Address	"@0?DN"+CR	Address	"@0DNXXXXXXXXXXXX"+CR
Password	"@0?PD"+CR	Password *2	"@0PDXXXXXXXXXXXX"+CR

*2: 0 to 12 digits

GPIO (Parallel) CONTROL

Use this to control the DN-C640 with dry contact circuit connections.

(1) Interface Condition

- Applicable connector: 25-pin D-sub (male)
- Connecting signal layout

Pin No.	Signal Name	I/O
1	FG	–
14	PLAY tally	O
2	PLAY command	I
15	PAUSE tally	O
3	PAUSE command	I
16	CUE tally	O
4	CUE command	I
17	INDEX2/INDEX3	O
5	TRACK (+) command	I
18	Reserved	–
6	TRACK (–) command	I
19	Reserved	–
7	SEARCH (Fwd) command	I
20	Reserved	–
8	SEARCH(Rev) command	I
21	Reserved	–
9	FADER START command	I
22	Tally power supply	–
10	Command common	–
23	Command common	–
11	NC	–
24	EOM tally	O
12	Reserved	–
25	Reserved	–
13	Reserved	–

NOTE:

- The tally output pin has open collector IC specifications (I_{max}. 48mA, V_{max}. 5.5V).
- The tally input pin has LVTTTL IC specifications (V_{cc} 3.3V).
- Maximum current for Tally power supply (Pin 22) is 100mA.

5. CONTROL FEATURES

(2) Remote control circuit

- Remote control connections

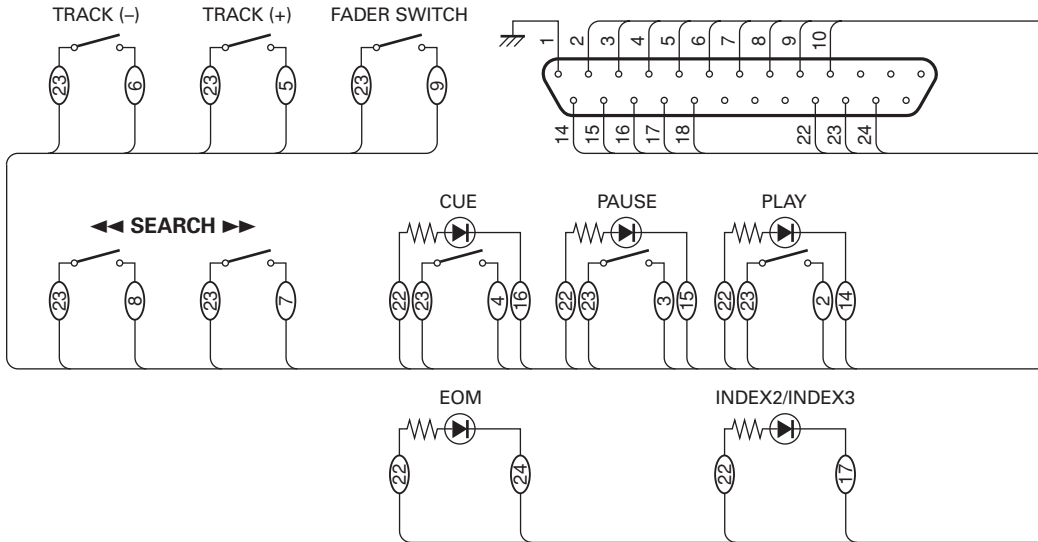

NOTE:

- The rating of REMOTE connector pin 22 (TALLY POWER SUPPLY) is +5 VDC, 100 mA maximum. Avoid currents in excess of the rating, or it may cause a malfunction or a risk of fire.

6. TROUBLESHOOTING

Make sure of the followings before you consider as any malfunctions :

1. Are all the connections correct?
2. Are all system components being operated correctly in accordance with the operating instructions?
3. Are the speakers and amplifier/receiver functioning correctly?

If the Unit still does not function properly, check the symptom against the list below. If the symptom does not correspond to the check list, please contact your dealer.

Problem	Cause	Remedy
Disc is not ejected.	<ul style="list-style-type: none"> • Power operation switch is not turned on. 	<ul style="list-style-type: none"> • Turn the power operation switch on.
When a disc is loaded, "TOC Error" or "No Disc" is displayed.	<ul style="list-style-type: none"> • Disc is not properly loaded. 	<ul style="list-style-type: none"> • Reload the disc.
When a disc is loaded, "Disc Error" is displayed.	<ul style="list-style-type: none"> • The disc is not properly recorded. 	<ul style="list-style-type: none"> • Turn the power off and on again to eject the disc.
When the PLAY button is pressed, playback does not start.	<ul style="list-style-type: none"> • Disc is dirty or scratched. 	<ul style="list-style-type: none"> • Clean the disc.
There is no sound, or it is distorted.	<ul style="list-style-type: none"> • Output cord is not properly connected. • Amplifier adjustment is inappropriate. 	<ul style="list-style-type: none"> • Connect the output cord properly. • Readjust the amplifier.
A specific section of the disc will not play.	<ul style="list-style-type: none"> • Disc is dirty or scratched. 	<ul style="list-style-type: none"> • Clean the disc.
Program play does not work.	<ul style="list-style-type: none"> • Program play operation has been performed improperly. 	<ul style="list-style-type: none"> • Restart Program play.
Remote control is not working.	<ul style="list-style-type: none"> • No batteries or flat batteries. 	<ul style="list-style-type: none"> • Ensure that batteries are correctly inserted. • Replace the batteries with a fresh set.
File does not play.	<ul style="list-style-type: none"> • Decoding Error. 	<ul style="list-style-type: none"> • Check that the file you are trying to play has a supported file extension and is a format that the DN-C640 supports.
Network is not working.	<ul style="list-style-type: none"> • Network type is wrong. • Network settings are incorrect. • Network cable is not plugged in. 	<ul style="list-style-type: none"> • Ensure that you have selected the correct network type. • Check your network settings. • Check the network cable is correctly plugged in on both the DN-C640 and your network switch.

7. SPECIFICATIONS

■ GENERAL

Disc type : Standard compact discs (12 cm and 8 cm)
CD-R, CD-RW, DVD-R, DVD-RW, DVD+R, DVD+RW

■ AUDIO SECTION

Audio channel : 2 channel stereo
Frequency response : 10 to 20,000Hz \pm 1.0 dB
Dynamic range : 98 dB
Signal-to-noise Ratio : 104 dB (1kHz, 0 dB playback, A filter)
Channel separation : 96 dB (1kHz, 0 dB playback, A filter)
Total Harmonic Distortion : 0.004 % (1kHz, 0 dB playback, A filter)
Analog output :
Unbalanced output (RCA) : 2.0 Vrms at 0 dB disc, 10 kohms
Variable range(VARIABLE) : 4.0 Vrms at 0dB disc, volume max.
Balanced output (XLR) : +18 dBu at 0 dB disc, 600 ohms
Variable range : +24 dBu to +0 dBu at 0 dB disc
Digital output :
Unbalanced output (RCA) : 0.5 Vp-p, 75 ohms
Balanced output (XLR) : 3.5 Vp-p, 110 ohms
Signal Format : SPDIF or IEC-958 Type II /AES EBU selectable
Headphone Output : 20 mW, 33 ohms
Variable Pitch Control : \pm 12 % max.
Frame Search Accuracy : 1/75 second

■ SIGNAL SYSTEM

Sampling Frequency: 44.1 kHz at Normal Pitch
Quantization : 16-bit Linear

■ REMOTE CONTROL

Ethernet (LAN) : RJ-45, 10BASE-T/100BASE-TX automatic selection
Serial remote : RS232C, D-Sub 9-pin
Parallel remote : D-Sub 25-pin
IR control input : IR sensor

■ POWER SUPPLY

U.S.A. & Canada models : 120 V AC \pm 10 %, 60 Hz
European, U.K. and Asia/Pacific models : 230 V AC \pm 10 %, 50 Hz
Power Consumption : 25 W (U.S.A. & Canada models)
25 W (European, U.K. and Asia/Pacific models)

■ CABINET, etc.

Installation : 19-inch 1U rack space
Maximum Dimensions : 482.6 (W) \times 44 (H) \times 325 (D)mm
19" (W) \times 1.7" (H) \times 12.8" (D)
Weight : 4.3 kg, 9.5 lbs

■ ENVIRONMENTAL CONDITIONS

Operating temperature : +5°C to +35°C
Operating humidity : 25% to 85%, non condensing
Storage temperature : -20°C to +60°C
Storage humidity : 25% to 85%, non condensing

■ DIMENSIONS

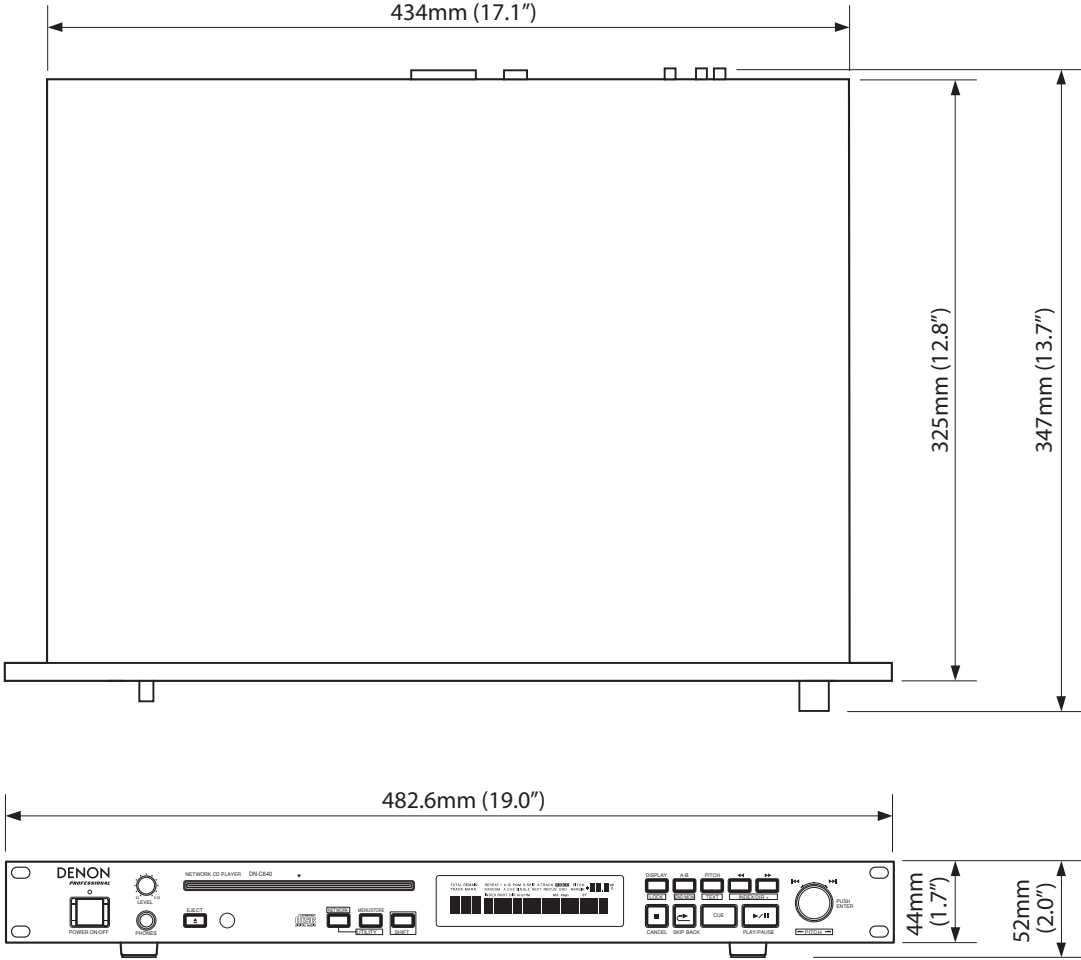

* For improvement purposes, specifications and design are subject to change without notice.

D&M Holdings Inc.
PROFESSIONAL BUSINESS COMPANY

