



BROADCAST EQUIPMENT COMPANY

USER AND MAINTENANCE MANUAL

ETG300
ETG300DR
ETG250
ETG250DR



TECHNICAL ANNEX



Via G. Amendola 9 - 44028 Poggio Renatico (FE) - Italy
Phone. +39 0532 829 965 - Fax +39 0532 829 177
E-Mail: info@elenos.com
Internet address: www.elenos.com

Edition 1
Rev. 1 - 14/05/2001
Cod. MAN0075

Dear User,

Firstly, thank you for choosing an **ELENOS** product.

ELENOS products are solid state or thermionic tube transmitters that develop power from a minimum of 20W to a maximum of 30KW.

Great care has been taken during the design of the protection circuitry to ensure compatibility with products from other manufacturers. However the best performance is achieved when the equipment is used with other products manufactured by **ELENOS**.

The unit has been designed to guarantee consistent performance over time, without the need for special maintenance. The need for this is minimised by regular functional checks of those components which are ventilated.

Operation of the unit is very easy and intuitive. Even so it is recommended that this manual and other relevant documentation is read carefully before any operation is attempted.

Customer Care

CONTENTS

1. GENERAL

- 1.1. Front ViewPage 5
 - 1.1.1. Front panel descriptionPage 5
- 1.2. Rear View.....Page 7
 - 1.2.1. Rear panel description.....Page 7



2. INSTALLATIONPage 9



3. USER INSTRUCTIONS

- 3.1. User interfacePage 10
- 3.2. Telemetry connection and operationPage 11
- 3.3. Powering upPage 13
- 3.4. Description of the graphics interface, setup and measurement
 - 3.4.1. Main menuPage 14
 - 3.4.2. Functions menuPage 15
 - 3.4.3. Audio menu - Input signal level adjustmentPage 16
 - 3.4.4. RF menu - Output power adjustmentPage 17
 - 3.4.5. Frequency menu - Frequency programmingPage 18
 - 3.4.6. User setup menu.....Page 19
 - 3.4.7. Timer displayPage 20
 - 3.4.8. RDS menu - RDS adjustment and programming (optional)Page 21
 - 3.4.9. Deviation e Statistics menuPage 25
 - 3.4.10. RDS encoder programmingPage 27
- 3.5. Checking performance.....Page 39



4. GENERAL DESCRIPTION

- 4.1. Introduction.....Page 41
- 4.2. Using the block diagramPage 41
- 4.3. Block diagram
 - 4.3.1. Transformer versionPage 43*
 - 4.3.2. Switch-mode versionPage 45*
- 4.4. Power supply sectionPage 47
 - 4.4.1. ServicesPage 47
 - 4.4.2. Power
 - 4.4.2.1. Switch-mode versionPage 47
 - 4.4.2.2. Transformer version.....Page 48
- 4.5. Radio frequency sectionPage 48
 - 4.5.1. DriverPage 48
 - 4.5.2. RF modulePage 49
 - 4.5.3. Low-pass filterPage 49
 - 4.5.4. Probe
 - 4.5.4.1. Output power measurementPage 49
 - 4.5.4.2. AGC protectionPage 49
- 4.6. Logic (Mother board)Page 50
 - 4.6.1. CPU board.....Page 50
 - 4.6.2. ALC boardPage 50
 - 4.6.3. VCO/PLL board.....Page 50
 - 4.6.4. MPX boardPage 50
- 4.7. KeyboardPage 50
- 4.8. Optional boards.....Page 51
 - 4.8.1. Stereo input boardPage 51
 - 4.8.2. Stereo encoder boardPage 52

| | | |
|--------|-----------------|---------|
| 4.8.3. | RDS board | Page 53 |
|--------|-----------------|---------|



| | | |
|----------|------------------------------------|----------|
| 5. | ELECTRICAL SCHEMATICS | |
| 5.1. | Auxiliary power supply | |
| 5.1.1. | Layout..... | Page 57 |
| 5.1.2. | Schematic | Page 59* |
| 5.1.3. | Parts list | Page 61 |
| 5.2. | Switching power supply | |
| 5.2.1. | Layout..... | Page 63 |
| 5.2.2. | Schematic | Page 65* |
| 5.2.3. | Parts list | Page 67 |
| 5.3. | Mother board | |
| 5.3.1. | Layout..... | Page 71* |
| 5.3.2. | Schematics | |
| 5.3.2.1. | VCO | Page 73* |
| 5.3.2.2. | PLL | Page 75* |
| 5.3.2.3. | MPX | Page 77* |
| 5.3.2.4. | AGC and SWR protection..... | Page 79* |
| 5.3.2.5. | CPU | Page 81* |
| 5.3.3. | Parts list | Page 83 |
| 5.4. | Keyboard | |
| 5.4.1. | Layout..... | Page 93 |
| 5.4.2. | Schematic | Page 95* |
| 5.4.3. | Parts list | Page 97 |
| 5.5. | Driver | |
| 5.5.1. | Layout..... | Page 99 |
| 5.5.2. | Schematic | Page 100 |
| 5.5.3. | Parts list | Page 101 |
| 5.6. | RF final output stage | |
| 5.6.1. | Layout..... | Page 103 |
| 5.6.2. | Schematic | Page 104 |
| 5.6.3. | Parts list | Page 105 |
| 5.7. | LP filter | |
| 5.7.1. | Layout..... | Page 107 |
| 5.7.2. | Schematics | |
| 5.7.2.1. | Directional coupler | Page 108 |
| 5.7.2.2. | Directional coupler amplifier..... | Page 109 |
| 5.7.2.3. | Low-pass filter | Page 110 |
| 5.7.3. | Parts list | Page 111 |
| 5.8. | Input output combiner system | |
| 5.8.1. | Schematic | Page 113 |
| 5.9. | BUS board | |
| 5.9.1. | Layout..... | Page 115 |
| 5.9.2. | Schematic | Page 116 |
| 5.9.3. | Parts list | Page 117 |
| 5.10. | Thermal probe | |
| 5.10.1. | Layout..... | Page 119 |
| 5.10.2. | Schematic | Page 119 |
| 5.10.3. | Parts list | Page 120 |



| | | |
|----|-----------------------|----------|
| 6. | TROUBLESHOOTING | Page 121 |
|----|-----------------------|----------|



| | | |
|----|-------------------------------|----------|
| 7. | TECHNICAL SPECIFICATION | Page 123 |
|----|-------------------------------|----------|

Page numbers marked with an asterisk (*) are in A3 format

1.1. Front view

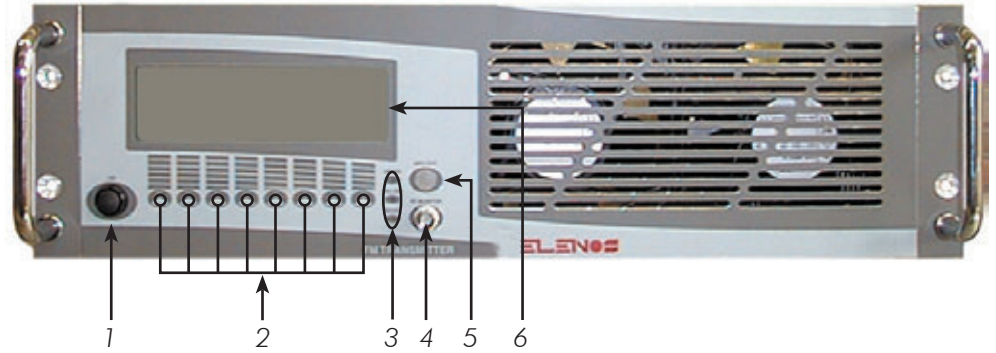

1.1.1. Front Panel description

- 1) Power on switch
- 2) Switches for programming operation
- 3) Led: "ON AIR" lit, indicates the PLL has reached the desired frequency
"FAILURE" lit, indicates the output power is below the preset threshold
"MAINS" lit, indicates the unit is switched on
- 4) The "RF monitor" connector provides an RF monitor signal
- 5) The "MPX OUT" connector provides an audio signal
- 6) Display

N.B.

Do not obstruct the ventilation grills

1.2.
Rear view

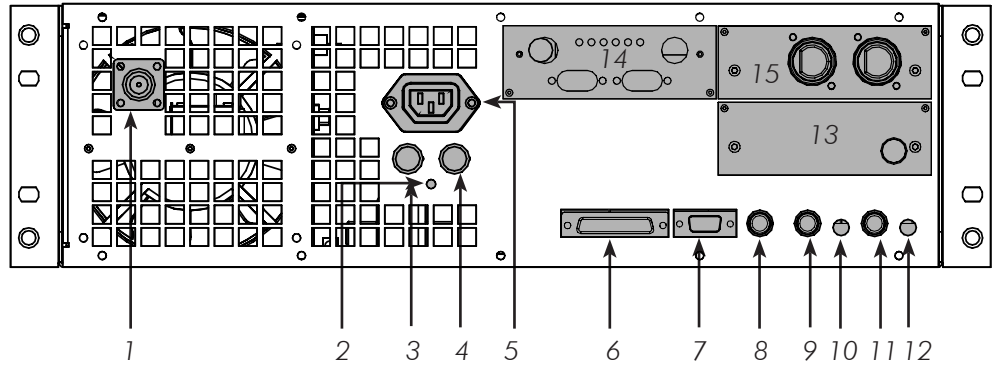

1.2.1.
Rear Panel description

- 1) "RF OUT" connector
- 2) Earthing terminal
- 3-4) Power supply fuse (10A)
- 5) Line supply socket
- 6) Analog signal interface
- 7) Telemetry interface
- 8) "MPX" input connector
- 9) "SCA2" input connector
- 10) Trimmer for calibrating the "SCA2" input
- 11) "SCA1" input connector
- 12) Trimmer for calibrating the "SCA1" input
- 13) Slot for inserting the stereo encoder board
- 14) Slot for inserting the RDS board
- 15) Slot for inserting the stereo inputs board

N.B.

Do not obstruct the ventilation grills

2. Installation



Remove the unit from its packaging and before attempting any operation, check that the unit has not been damaged during transport and that all the switches and connectors located on the front and rear panels are serviceable.

- ☞ Install the unit so that it is accessible from all sides
- ☞ Ensure that the location of the unit allows for connection to an efficient earthing point
- ☞ Ensure that the antenna system is suitable
- ☞ Check that any amplifier to be eventually connected downstream is connected to the antenna system
- ☞ Connect the appropriate inputs of the exciter according to the type of operation required:
 - ☞ the monophonic signal to the XLR connector on the mono board
 - ☞ the stereo signal (low frequency) to the left and right XLR connectors on the stereo input board
 - ☞ the stereo signal (wide-band) to the MPX connector on the MPX and SCA inputs board
 - ☞ the RDS signal to one of the two SCA connectors on the MPX and SCA inputs board
 - ☞ If the RDS board is fitted, the wide-band stereo signal goes directly to the MPX inputs on the RDS board, so the MPX+RDS output will be connected to the MPX input on the MPX and SCA inputs board.
- ☞ Connect the electricity supply cable
- ☞ Connect the RF output to the input of any amplifier to be used, or to the antenna system
- ☞ Switch on the amplifier (if present)
- ☞ In order to verify that the equipment is functioning correctly, check the values displayed by the exciter and amplifier displays and instrumentation

3.1.
User interface

The user interface is designed to accept upto 14 analog signals in the range 0 to 2V. For example, it is possible to read a remote temperature, remote voltages and currents of other equipment and direct and reflected power of other equipment.

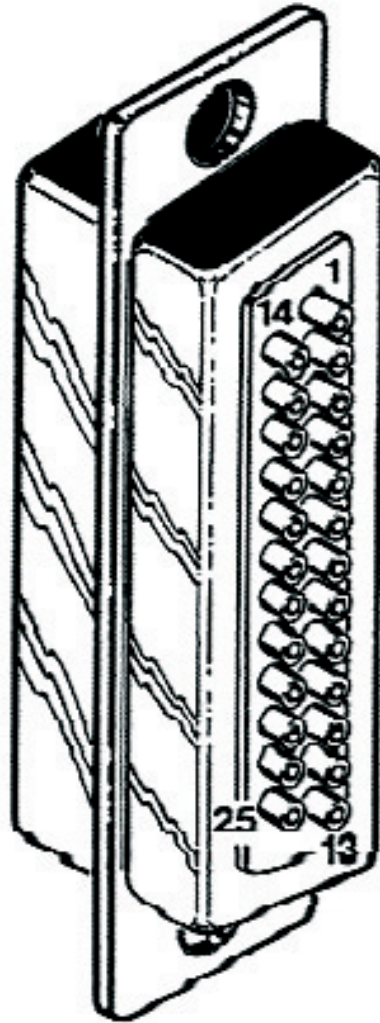

| | |
|----|--------------------------|
| 1 | IN1 = SB_ON |
| 2 | IN2 = SB_OFF |
| 3 | GND |
| 4 | GND |
| 5 | IN3 = VDS 5V.F.S. |
| 6 | IN4 = IDRAIN 5V.F.S. |
| 7 | NC |
| 8 | IN5 = LOCK REM. |
| 9 | IN6 = +5V. REM. |
| 10 | IN7 = RPW REM. |
| 11 | IN8 = CUR REM. |
| 12 | IN9 = IPW REM. |
| 13 | IN10 = V. REF. REM. |
| 14 | GND |
| 15 | GND |
| 16 | NC |
| 17 | GND |
| 18 | IN11 = STAND-BY |
| 19 | IN12 = REF. PWR 1V.F.S. |
| 20 | IN13 = DIR PWR 3.6V.F.S. |
| 21 | IN14 = TMP REM. |
| 22 | IN15 = VPW REM. |
| 23 | IN16 = FPW REM. |
| 24 | IN17 = -12V. REM. |
| 25 | IN18 = +12V. REM. |

Pins with an "IN" prefix are inputs
Pins with an "NC" prefix are not connected
Pins with a "GND" prefix are earths

To enable external RF OFF function (stand by) after having switched on the device, during countdown, press P2 and P7 at the same time, enter the password (2222, press P2 four times) enable "EXT RF OFF" and save the new configuration.

3.2.
*Telemetry
Connection
and operation*



The ETG250's (ETG300's) telemetry feature allows an IBM compatible PC to be connected directly to the unit, or via a GSM modem. The main operational parameters can be displayed and modified via telemetry using the Hyper Terminal software supplied with any version of Microsoft Windows (c).

Connect the unit to a GSM modem, or directly to a PC, using the cable supplied (see diagram below).

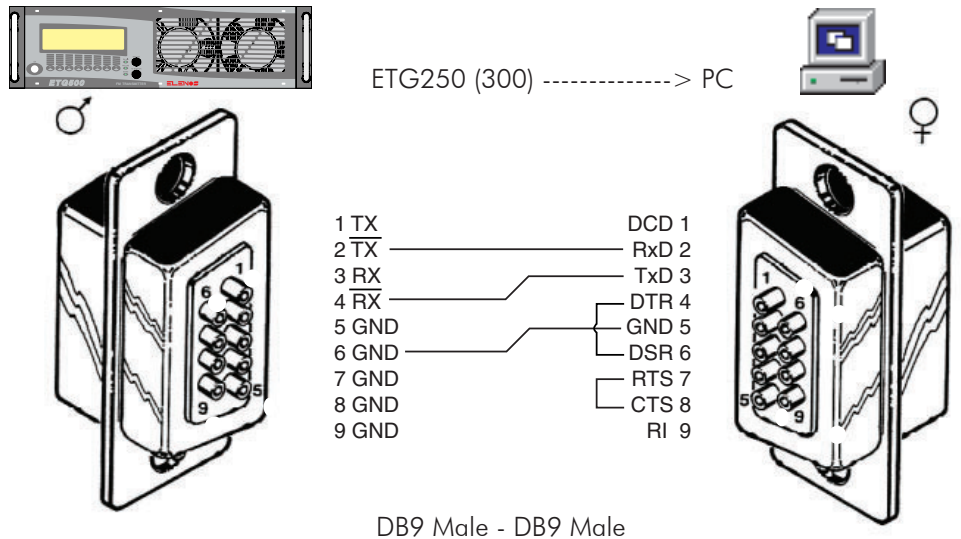
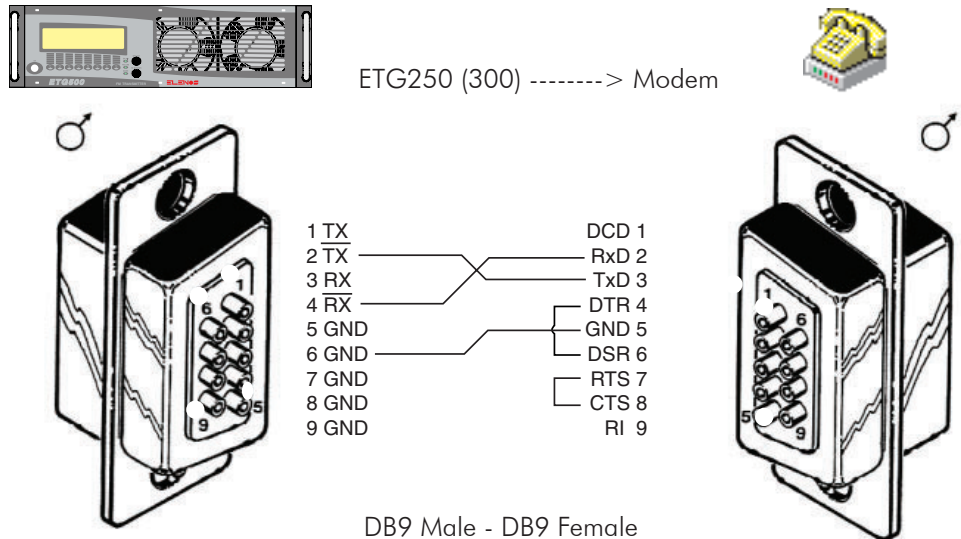

Run the Hyper Terminal software supplied with Microsoft Windows. Enable the connection (to connect via modem, refer to the configuration in the GSM modem manual).

Telemetry will now be available on the PC, but to transfer data, the code \$1111 must be entered; only then may the unit's parameters be displayed and modified.

3.2. Main Screen
*Telemetry
Connection
and operation*

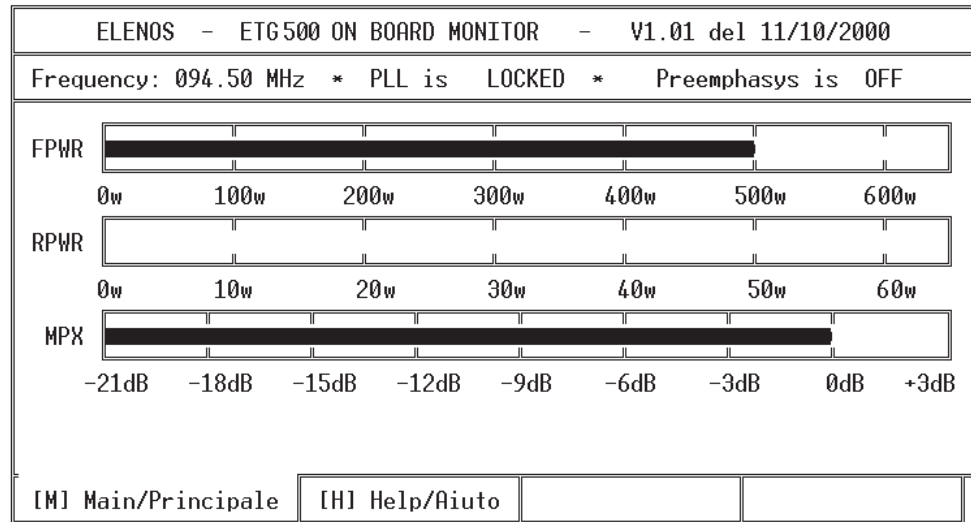

The following parameters can be viewed on the main screen: the programmed frequency, the status of the PLL, the status of pre-emphasis, the level of direct power, the level of reflected power and the audio level.

From this screen the output power can be increased or decreased by pressing the "P" key with either the "+" or "-" keys respectively. Once the desired value has been reached, it can be saved by pressing the "S" key.

To modify the frequency, press the "F" key with either the "+" or "-" keys to increase or decrease the frequency respectively. Once the desired frequency has been reached, it can be saved by pressing the "S" key.

To terminate transmission of data, type "\$C".

Pressing the "H" (help) key will open the help screen where all the above commands are identified (see diagram below).

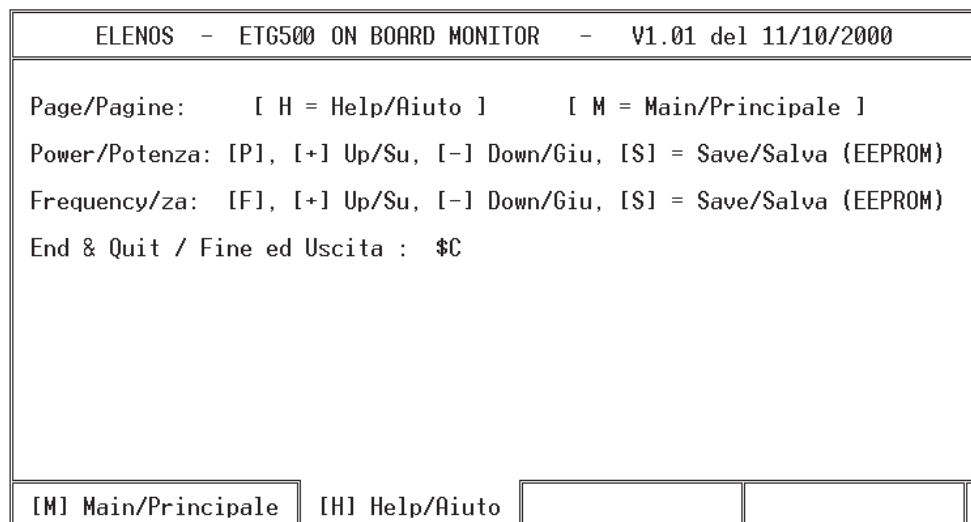

Press the "M" (Main) key to return to the main screen.

3.3.
Powering up

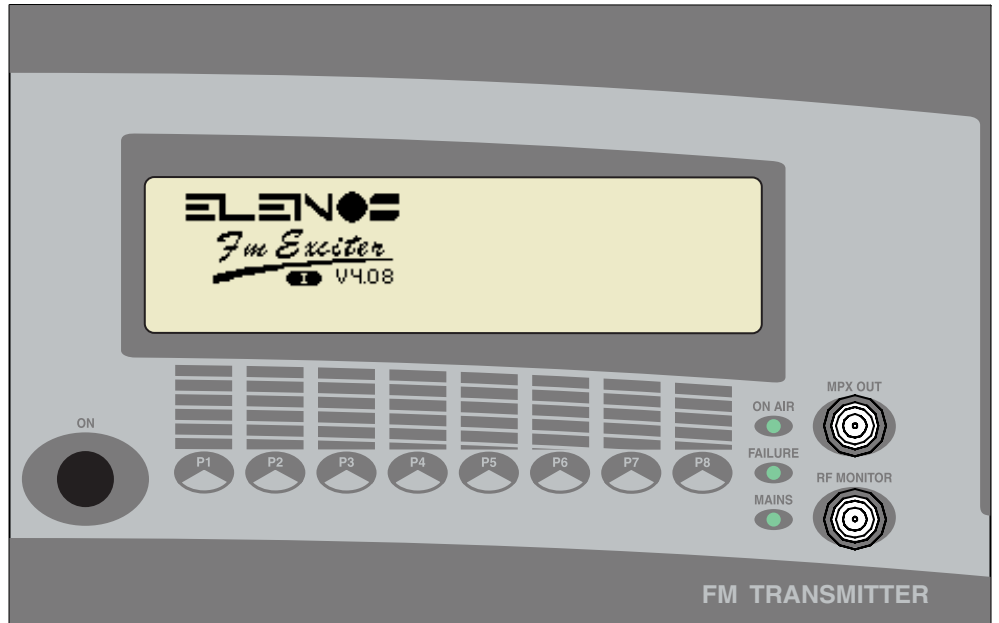

- The start up screen appears showing the state of the audio BUS.
- The microprocessor runs a system check to verify which optional boards have been fitted.
- The countdown starts (duration 8 seconds) after which the exciter will develop power.

Pressing keys during the countdown:

- ☞ Pressing any key will prevent power from being developed
- ☞ Pressing F1 +F8 will terminate the countdown

On termination of the countdown, the main menu will appear (with the ELENOS logo or that of the customer)

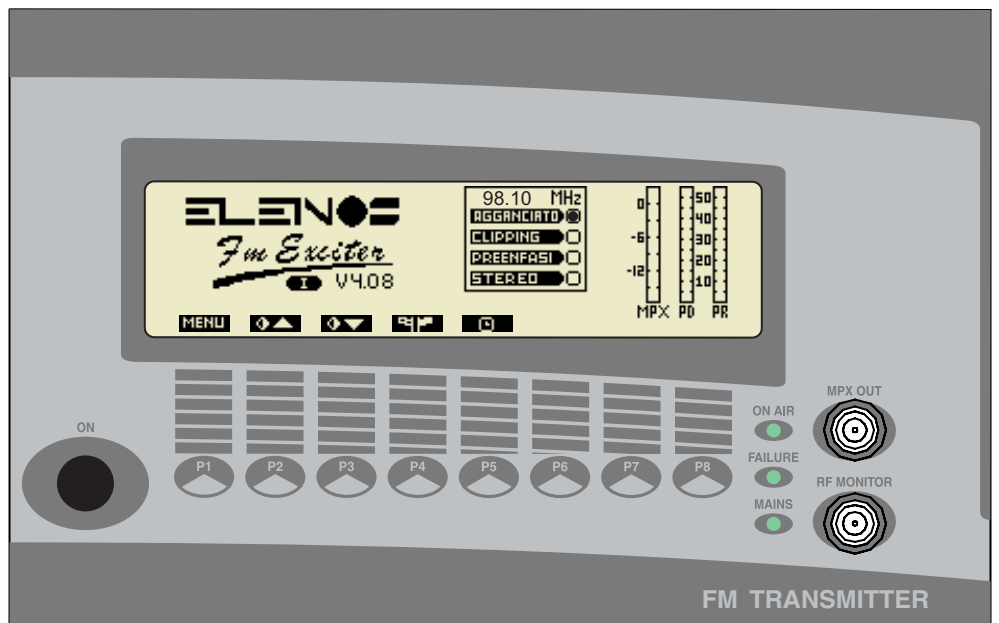

3.4.1.
Main Menu

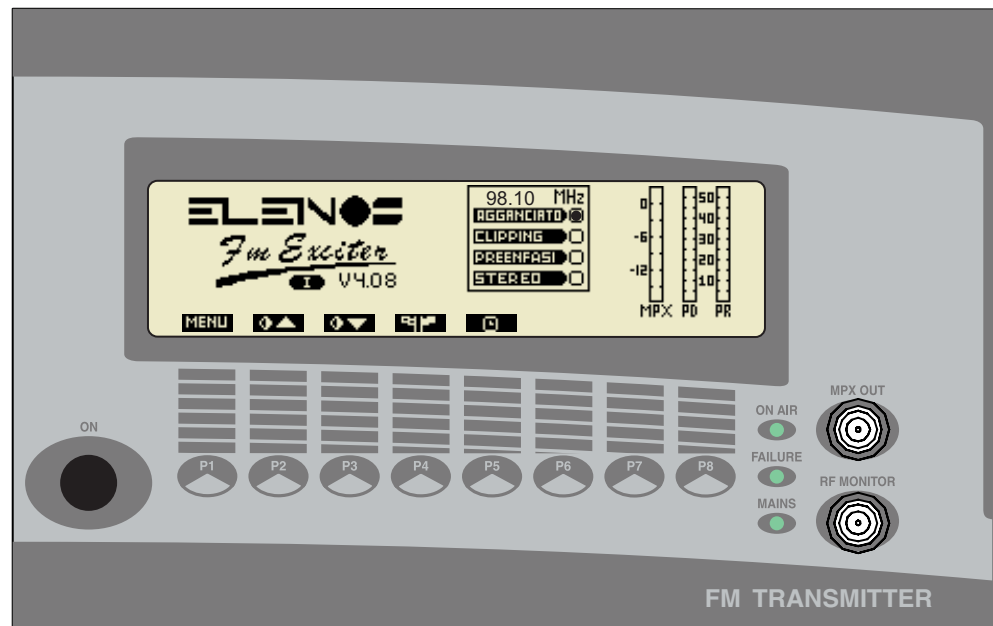

- ☞ Press key P1 to access the menu functions
- ☞ Press key P2 to increase the contrast of the display
- ☞ Press key P3 to reduce the contrast of the display
- ☞ Press key P4 repetitively to select the desired language
The language of the display will change each time the key is pressed
The language selected will be indicated by a letter under the ELENOS logo.
- ☞ Press key P5 to display the time for which the unit has been operated.

The main menu displays respectively: MPX level, direct power, reflected power, operating frequency, PLL lock, clipper operation, insertion of pre-emphasis and insertion of the stereo encoder.

The logo displayed by the unit can be personalised on the request of the user. The default logo is that of ELENOS with which is also displayed the version of software installed (e.g. V4.08) and the language selected (e.g. UK)

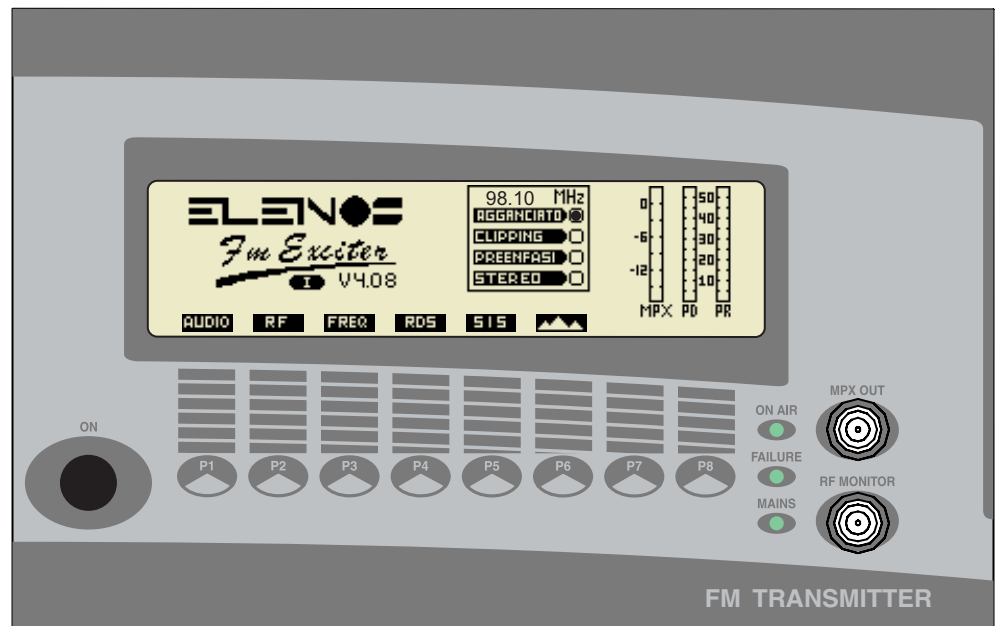
3.4.2.
Functions Menu

- ☞ Press key P1 to access the audio menu
- ☞ Press key P2 to access the RF menu
- ☞ Press key P3 to access the frequency programming menu
- ☞ Press key P4 to access the RDS menu if the optional RDS board is fitted
- ☞ Press key P5 to access the user setup menu
- ☞ Press key P6 to access the deviation and statistics menu

The following parameters are displayed in the Functions menu: MPX level, direct power, reflected power, operating frequency, PLL lock, clipper operation, insertion of pre-emphasis and activation of the stereo encoder.

Once the functions menu has been entered, if no key is pressed, the main menu will automatically appear after 10 seconds.

3.4.3. Adjustment of the input signal level Audio Menu

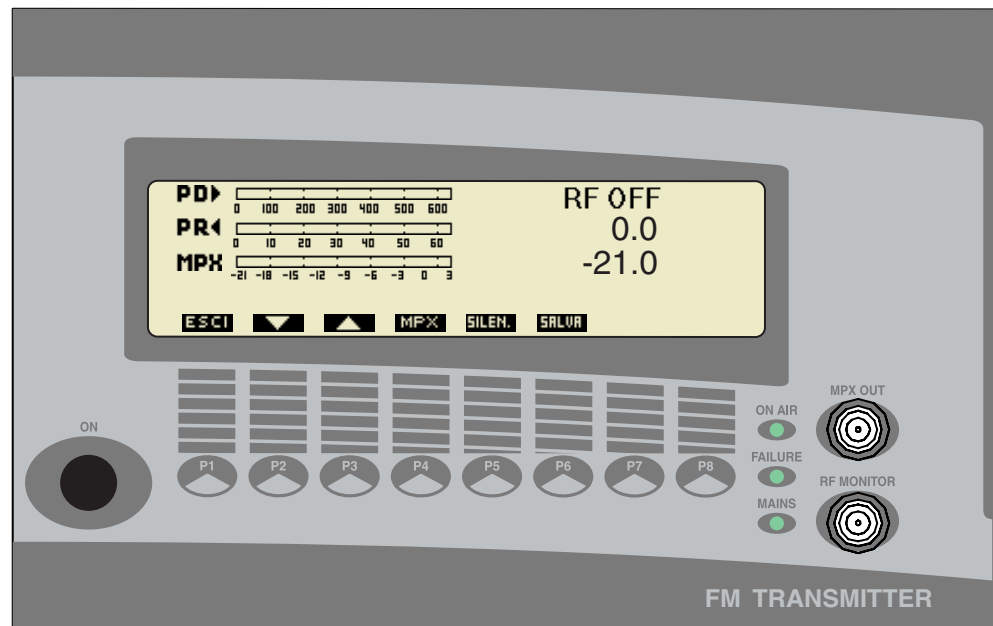

- Press key P1 to return to the functions menu
- Press key P4 to set the input signal level (default 0dBm)
- Press key P2 to reduce the input signal level
- Press key P3 to increase the input signal level
- Press key P6 to save the adjustment made
- Press key P5 to disable or re-enable the audio signal

The audio menu displays the following parameters: direct power, reflected power and MPX signal level in both “analog” and numerical form. In the diagram direct power is disabled (RF OFF), the reflected power is 0W and the MPX signal level is -21dBm.

If the stereo encoder is present, the indication of direct and reflected power is replaced by the level of the signals on the left and right channels.

3.4.4. **Adjustment of output power**
RF Menu

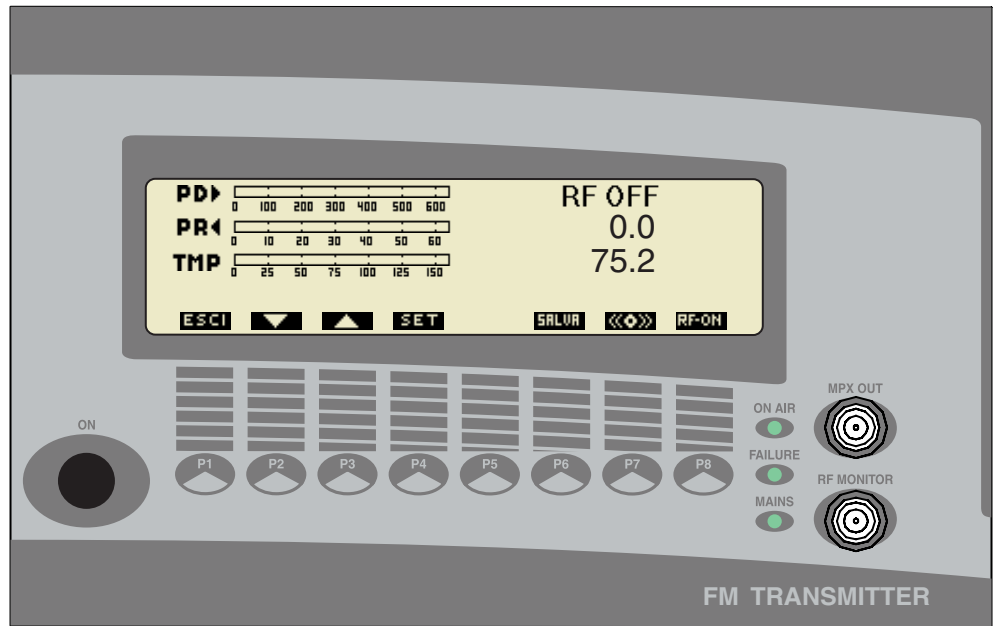

- ☞ Press key P1 to return to the functions menu
- ☞ Press key P4 to set the output power level from 0W to a maximum value of 500W
- ☞ Press key P2 to reduce the output power
- ☞ Press key P3 to increase the output power
- ☞ Press key P6 to save the adjustment made
- ☞ Press key P7 to activate or deactivate the output stage of the amplifier. For example, in the diagram, output power is disabled.

In the RF menu, the following parameters are displayed: direct power, reflected power and temperature in both “analog” and numerical form.

3.4.5. Adjustment of output frequency Frequency Menu

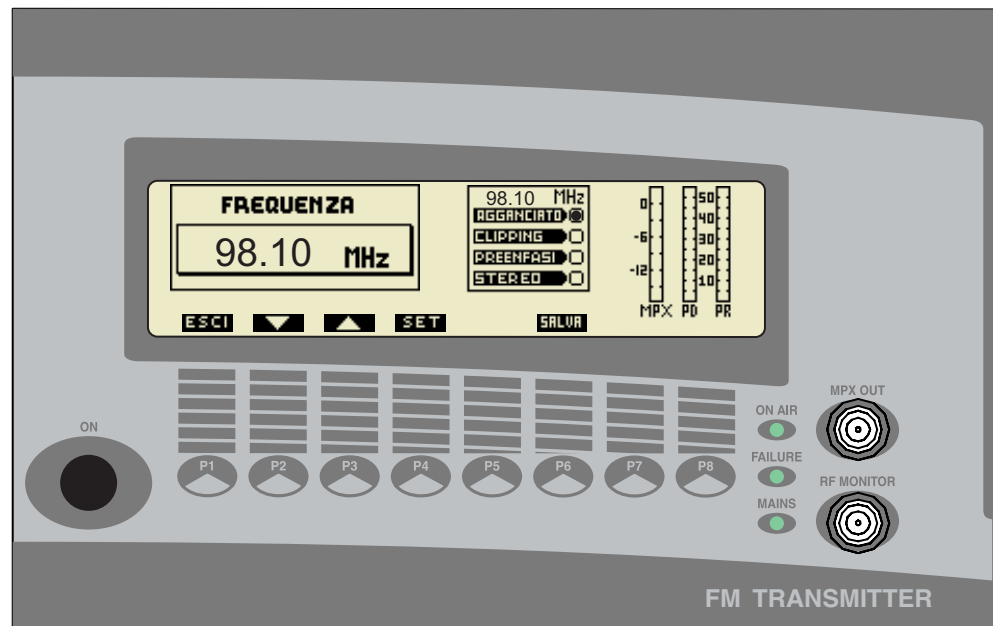

- Press key P1 to return to the functions menu
- Press key P4 to set the operating frequency
- Press key P2 to reduce the operating frequency
- Press key P3 to increase the operating frequency
- Press key P6 to save the adjustment made

The frequency menu displays the following parameters: MPX level, direct power, reflected power, operating frequency (highlighted), PLL lock, clipper operation, insertion of pre-emphasis and activation of the stereo encoder.

3.4.6.
User setup menu

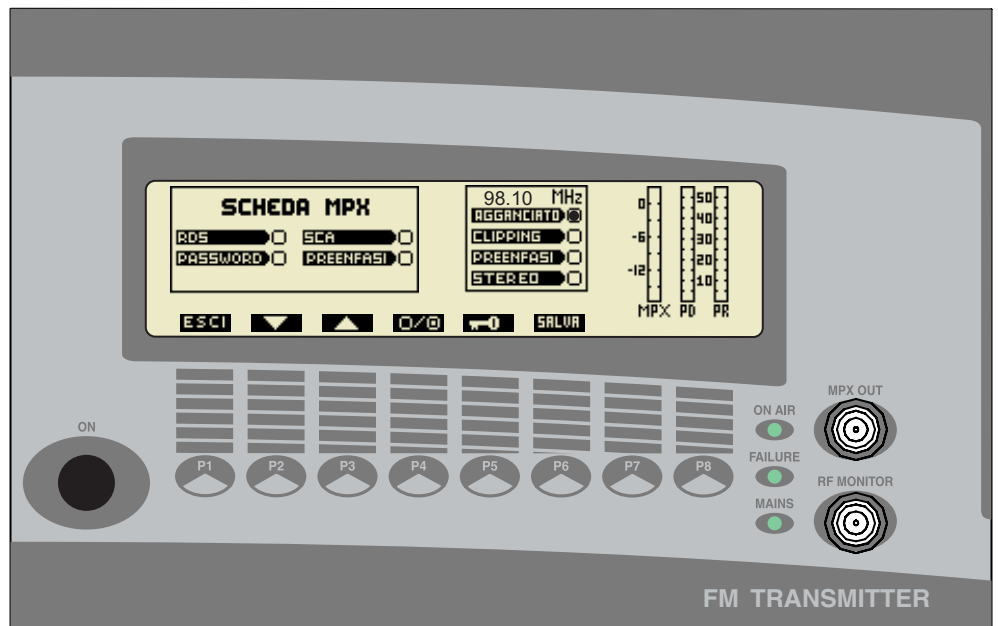

- ☞ Press key P1 to return to the functions menu
- ☞ Press key P2 to scroll the menu options from top to bottom
- ☞ Press key P3 to scroll the menu options from bottom to top
- ☞ Press key P4 to enable (circle filled) or disable (circle empty) the selected function
- ☞ Press key P6 to save the change
- ☞ Press key P5 to program a four figure password

The password restricts access to the audio, frequency, power and user setup menus by unauthorised personnel.

The following parameters are displayed in the user setup menu: MPX level, direct power, reflected power, operating frequency, PLL lock, clipper operation, insertion of pre-emphasis and activation of the stereo encoder.

3.4.7.
Timer Display

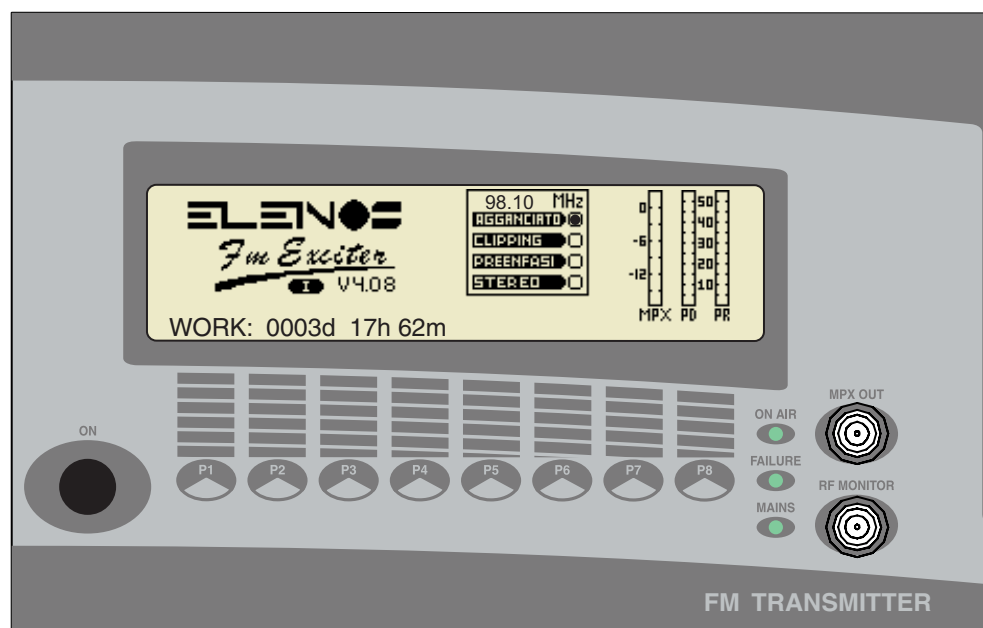

From the main menu, key P5 accesses the timer display which indicates the operating time of the unit in days (d), hours (h) and minutes (m).

3.4.8. **Adjustment of RDS settings (optional)**
RDS menu
(Optional)

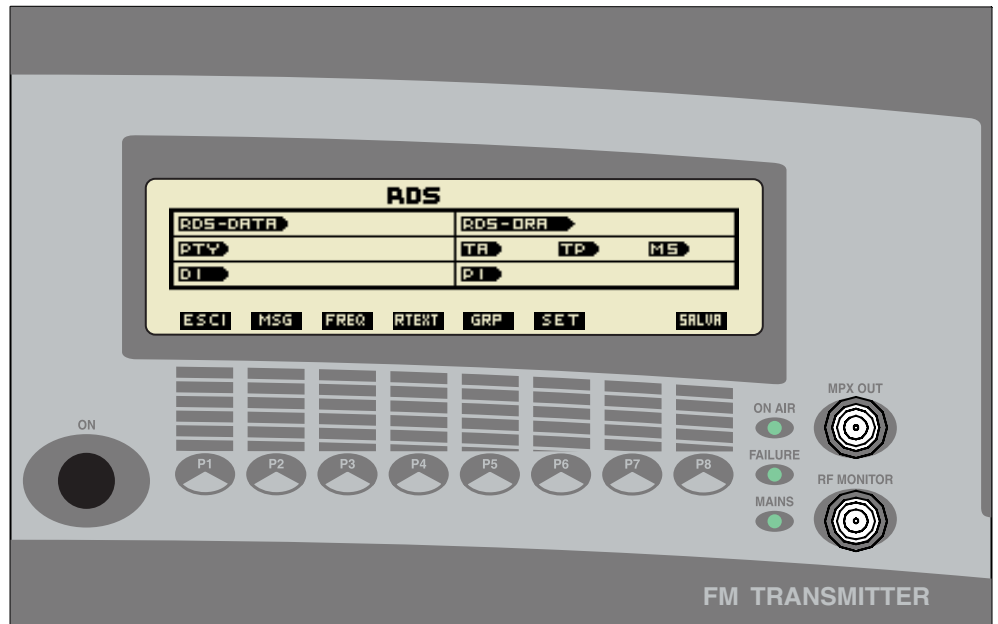

In function menu press P4 to enter RDS menu

- ☞ Press P1 to return to function menu
- ☞ Press P2 to enable RDS messaging settings
- ☞ Press P3 to enable alternative frequencies settings
- ☞ Press P4 to enable radio text settings
- ☞ Press P5 to enable groups settings
- ☞ Press P6 to set RDS Date and Time, PTY, DI, TA, TP, MS and PI
- ☞ Press P8 to save settings

3.4.8.
RDS Menu
(Optional)



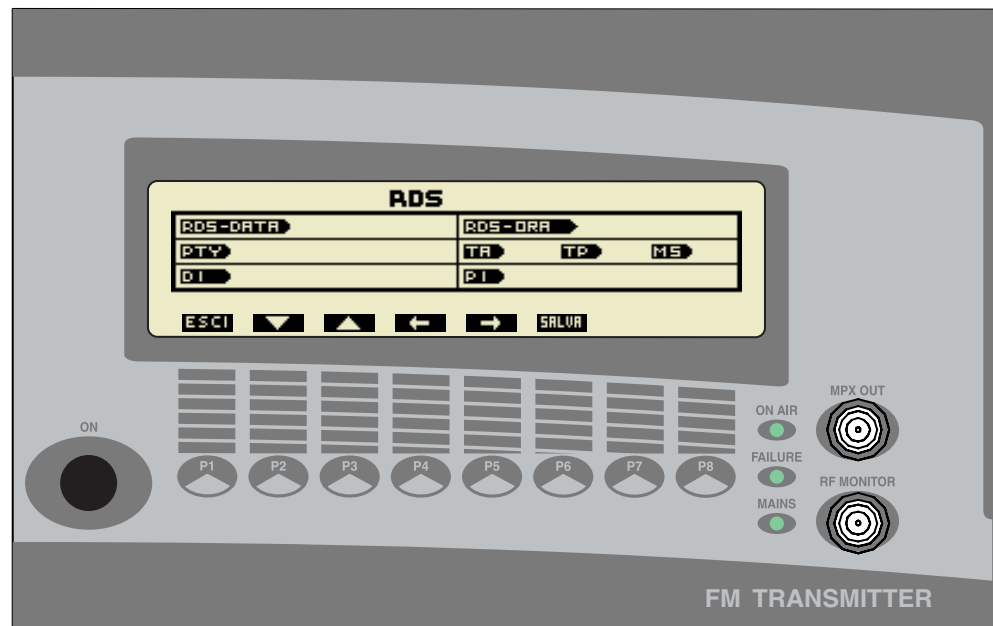

- From the RDS menu (page 21)
- Press key P6 to program RDS Date and Time, PTY, DI, TA, TP, MS and PI

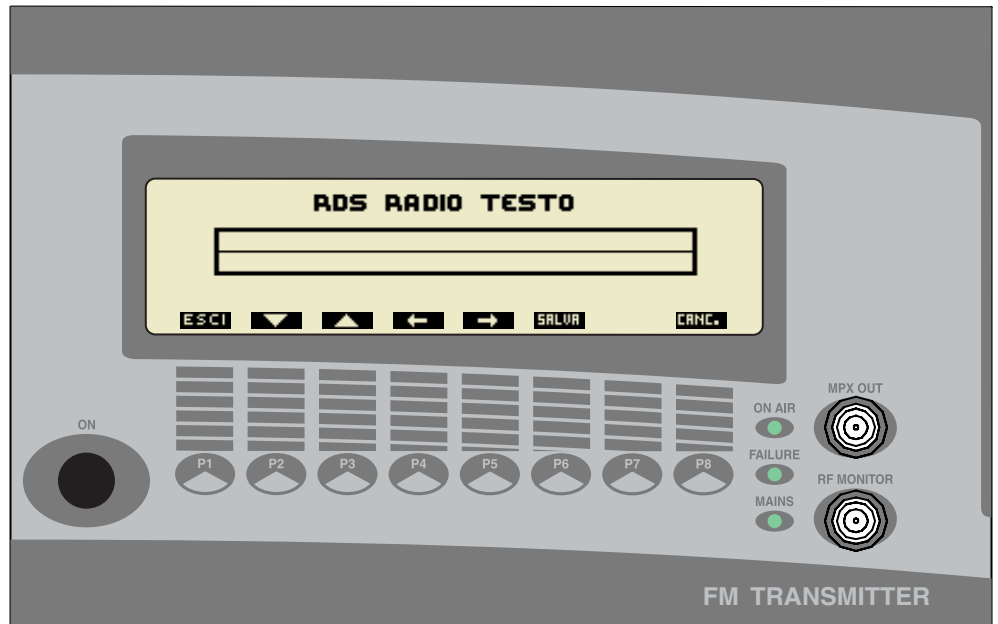

- Press key P1 to return to the main RDS menu
- Press keys P4 and P5 to select the data to modify
- Press keys P2 and P3 to select options for the selected data
- Press key P6 to save the changes made

- 3.4.8. From the RDS menu (page 21)
RDS Menu (Optional)  Press key P4 to set the RDS TEXT message



-  Press key P1 to return to the main RDS menu
-  Press keys P4 and P5 move the cursor
-  Press keys P2 and P3 to select the letter to insert
-  Press key P6 to save the changes made to the message
N.B. If unsaved, the previous message will remain unchanged
-  Press key P8 to delete the whole message

3.4.9.
Deviation and Statistics Menu

- From the functions menu (page 15)
- ☞ Press key P6 to display Deviation and Statistics

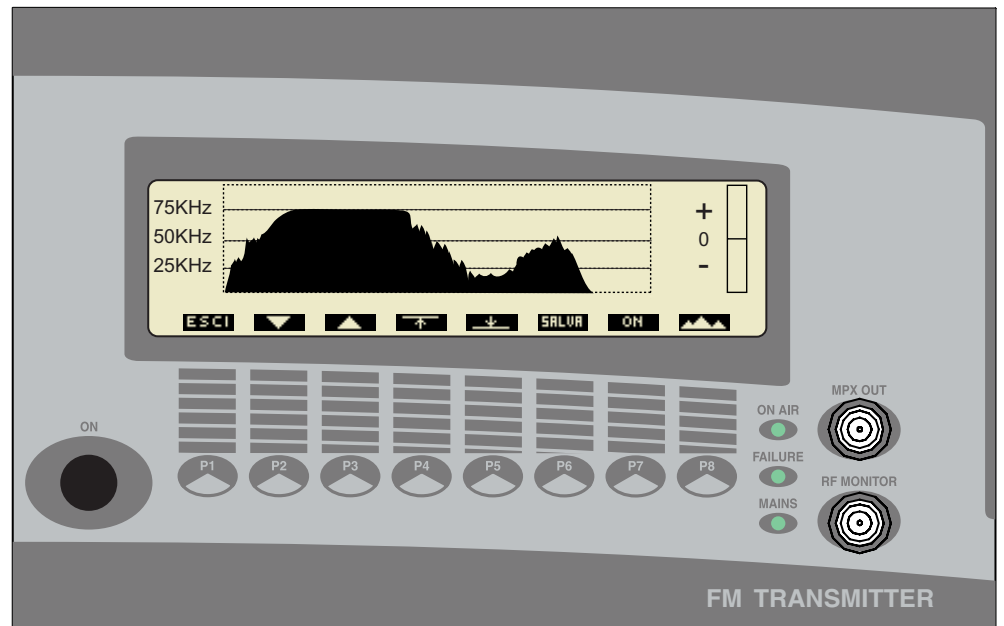

- ☞ Press key P1 to return to the main menu
- ☞ Press key P7 to enable or disable audio ALC (Automatic Level Control)
- ☞ Press key P4 * to set the upper threshold for ALC
- ☞ Press key P2 to reduce the value of the upper threshold
- ☞ Press key P3 to increase the value of the upper threshold
- ☞ Press key P6 to save the changes made
- ☞ Press key P5 * to set the lower threshold for ALC
- ☞ Press key P2 to reduce the value of the lower threshold
- ☞ Press key P3 to increase the value of the lower threshold
- ☞ Press key P6 to save the changes made

(*) Pressing keys P4 or P5 will cycle through the options to modify the threshold measured in KHz, in dB, and the response time of the Clipper in seconds.

N.B.

The status of the ALC is displayed by the right hand bar

- ☞ Press key P8 to access the statistics menu (see next page)

This window shows the absolute value of modulation (MPX) in time.
The graphics allow the modulation to be displayed over a period of several minutes of transmission.
To facilitate reading, the display is calibrated at values of 25, 50 and 75KHz.

3.4.9.
*Deviation and
Statistics Menu*

- From the deviation menu (page 25)
➤ Press key P8 to display Statistics

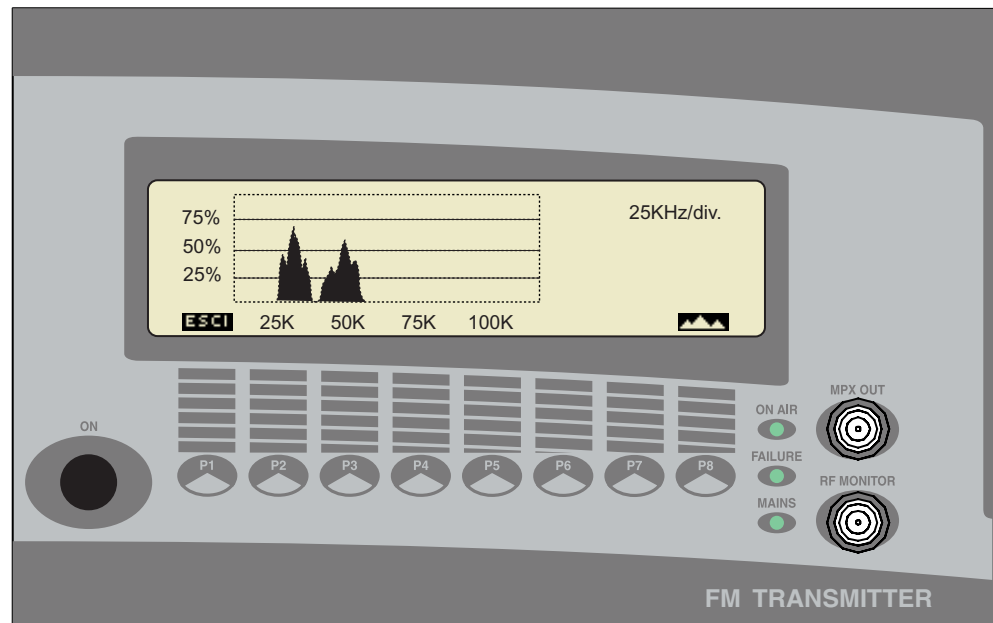

- Press key P1 to return to the main menu
➤ Press key P8 to return to the deviation menu (previous page)

This window displays the percentage modulation (MPX).
The graphics allow evaluation of how much deviation is present and the percentage exceeding 75KHz of deviation.

- Y AXIS: The grid highlights the values 0%, 25%, 75%, 100%
- X AXIS: The grid highlights deviation values 0, 25, 50, 75, 100KHz

3.4.10. RDS Encoder Programming

Each encoder is supplied with a 3.5" disk containing programming software for an IBM compatible PC.

Once installed, the software is already operational - just connect the PC to the encoder and switch it on to start programming it.

At start up a screen will appear asking whether COM1 or COM2 is used for the serial connection. A second screen will then appear, "Baud Rate Selection", which asks for the speed of the serial connection in baud. Select 2400 as the default.

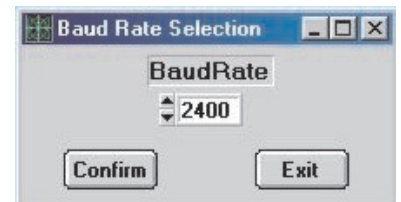

ATTENTION:

In the event that the correct serial port or baud rate has not been selected, the following message will appear:



This window will appear whenever an error is detected.

ATTENTION:

Whenever this programme is in use, ensure that you exit any ETG250 (ETG300) window that corresponds to RDS programming.

3.4.10.
 RDS Encoder
 Programming

Once the port and baud rate have been set, the PC will begin to upload encoder data to determine the data with which it has been programmed. When successfully completed, a screen will appear with three main sections: "PS Messages", "Alternative Frequencies" and "Program Identification".

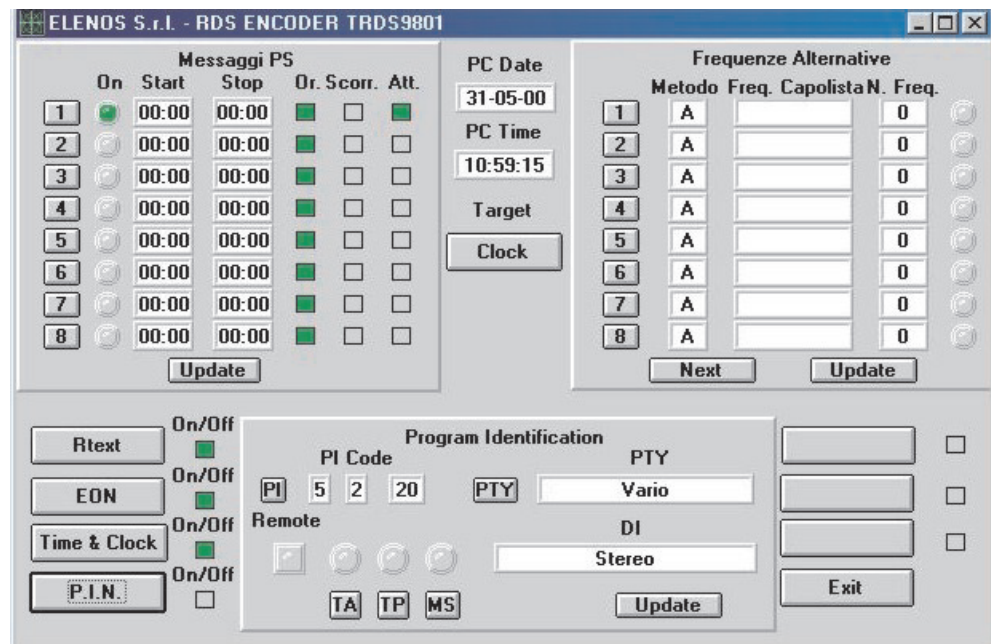

3.4.10.
RDS Encoder
Programming

PS Messages:

The "PS Messages" section shows 8 zones, each of which comprises the following fields:

- ✓ 1-8 keys to select the window for modifying the contents of the corresponding PS message.
- ✓ START text box corresponding to the time of start of transmission of the PS message. This field can only be modified if the OR key is lit.
- ✓ STOP text box corresponding to the time of the end of transmission of the PS message. This field can only be modified if the OR key is lit.
- ✓ ATT (active) key enabling the PS message to be transmitted on-air; if green, the message is on-air.
- ✓ OR (time) key enabling the on-air message to be timed; if OR and ATT are both green, the PS message will go on-air between the times specified by the START and STOP fields.
- ✓ SC (scroll) key enabling the transmission of the PS message in scrolling mode (one letter to the right every second).
- ✓ ON indicator (green) confirming that the corresponding message is on-air.

Active messages (ATT lit green) which are not timed (OR grey) will be transmitted consecutively during intervals when timed messages are inactive. To ensure that the video programming is in step with the encoder, press the "Update" key.

Procedure for programming message 1

- ☞ Press OR (time) so that it is lit green (time setting enabled)
- ☞ Click the mouse on the START window
- ☞ Delete the previous time (CANC key)
- ☞ Enter the start time (using the same format: "XX:XX")
- ☞ Click the mouse on the STOP window
- ☞ Delete the previous time (CANC key)
- ☞ Write the end time of the message
- ☞ Press key 1 (the message programming window will appear)

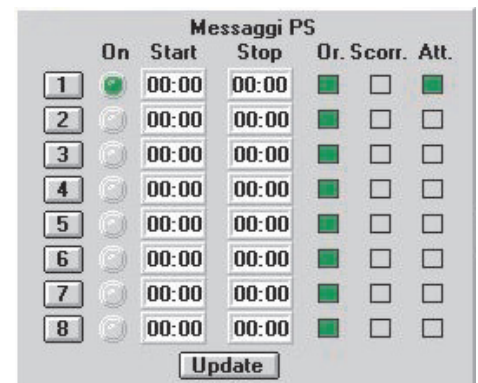

3.4.10. **Programming PS Messages**
RDS Encoder Programming

Having pressed one of the keys 1-8, corresponding to the number of the PS message to program, a window will appear with 16 fields for the words which make up the message, and the corresponding times for which the words will be displayed.

The times, in seconds, can be programmed from a minimum of 1 second to a maximum of 60 seconds and represent the time for which the word will be displayed before being replaced by the next word. However, if the message is programmed to scroll (the SC key is lit green in the previous window), the times displayed have no relevance.

N.B.

The fields which are left blank are not transmitted even if a display time of more than one second has been set.

Procedure for programming a message

1. Double click on the text box where a word is to be entered, and then enter the word
2. Adjust the display time of the word using the UP and DOWN arrows underneath the text box
3. Repeat steps 1 and 2 for all the other words to be programmed
4. Press the UPDATE key to save the message and exit from the window

Alternatively, press the EXIT key to exit from the window without saving the message

From the main window:

5. Press the ATT key (activate the message)
6. Press the UPDATE key to update (the green ON indicator will light to show the message is active)
7. It is now possible to insert other messages (upto 8) following the same procedure



3.4.10. **Alternative frequencies**
RDS Encoder
Programming

The Alternative frequencies section allows 16 lists of different frequencies to be programmed, each in mode A or B. 8 lists are displayed at a time and with each one, the mode (A or B) with which it was programmed, the header frequency (this field is filled only if mode B has been used) and the number of frequencies in the list. To access a list just click the corresponding key with the mouse; a display will appear showing the mode and the list of possible frequencies on the left, and the frequencies in the list on the right. Double-click on a frequency contained in the left-hand list and it will be added, if not already present, to the list on the right. With mode A, it is possible to create a list with a maximum of 25 frequencies compared with 12 in mode B.

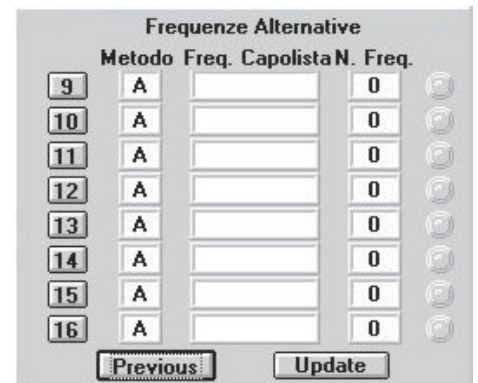
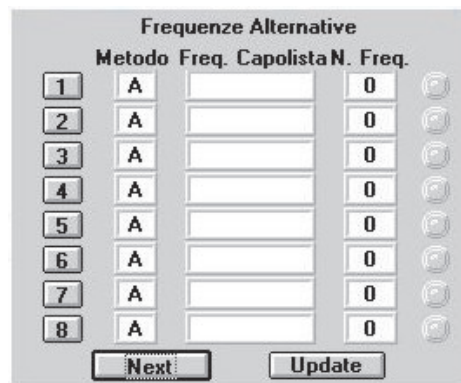

Method A/B

The EBU standard allows for the possibility of transmitting the set of frequencies to a network of transmitters in two modes, A and B.

- Method A allows transmission of one or more lists of frequencies, each upto a maximum of 25.
- Method B allows transmission of as many lists as there are transmitters in the network

Each list is headed with the frequency of the transmitter to which it corresponds and contains all the frequencies of adjacent transmitters.

Each receiver is designed to store a certain number of alternative frequencies which will be searched automatically for a new frequency when the current signal is too weak to receive. The search is as fast as the list of alternative frequencies is short. When the number of transmitters exceeds 12, it is advisable to use method B in which the receiver stores only the list corresponding to the header frequency to which it is tuned, so facilitating a faster change of frequency.

3.4.10.
RDS Encoder
Programming

Programming alternative frequencies

To correctly program alternative frequencies, follow the instructions in sequence:

1. From the main menu, click on the key corresponding to the list to program.
2. Select method A or B.
3. Scroll the list of frequencies and double-click the mouse on the desired frequency. The data will be inserted in the selected list of frequencies (right-hand list). With method B selected, the first selected frequency is the header frequency and appears in the relevant window. To delete any stored frequency, double-click on it with the mouse.
4. To save the selection, click on USCITA.
5. In the main menu a green indicator will appear to the left of the list being modified or programmed to show that data is being changed. Click the UPDATE key to store the new data in the RDS board.

At this point, further alternative frequencies may be programmed.

Esempi

Metodo A

Metodo B



Program identification

In this section parameters specific to the broadcaster are programmed; Program Identification, Program Type, Decoder Identification, Traffic Announcement, Traffic Program and Music/Speech.

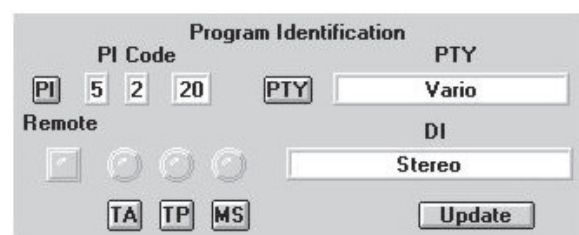

3.4.10.
RDS Encoder
Programming

Program identification PI

PI is an identification code comprising 3 fields: COUNTRY + DIFFUSIONE + CODE.

COUNTRY is a numerical value from 0 to 15 (0,F in hexadecimal) which identifies the country of the broadcaster (Italy - code 5).

DIFFUSIONE is a numerical value from 0 to 15 (0,F in hexadecimal) which identifies the area of coverage of the broadcast signal (local, regional, national, international).

CODE is a numerical value from 0 to 255 (00,FF in hexadecimal) which identifies the broadcaster; the code is assigned by an authorised organisation.

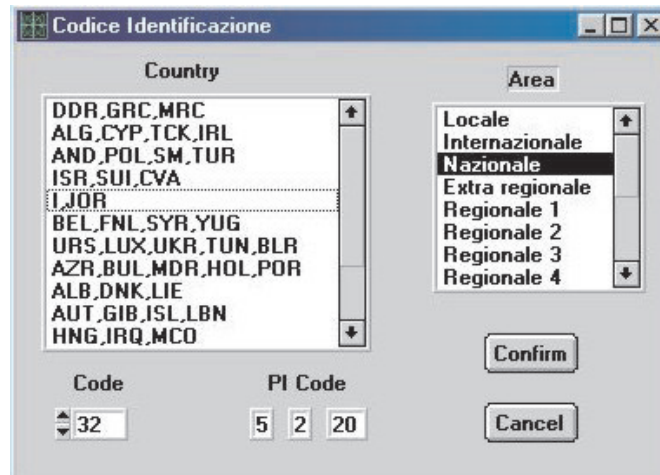

1. To program PI just click on the corresponding key with the mouse.
2. Double-clicking on the item will automatically enable the relevant codes.
3. Press the CONFIRM key to confirm the choice.
4. To exit without saving, press CANCEL

Program Type and Decoder Identification DI

PTY is a code with 32 values (from 0 to 31) which identifies the type of transmission being broadcast.

DI identifies 16 different operational modes that the broadcaster can use.

- Click the PTY key with the mouse to start programming
- To store the selection, press UPDATE.
- To exit without saving, press EXIT.

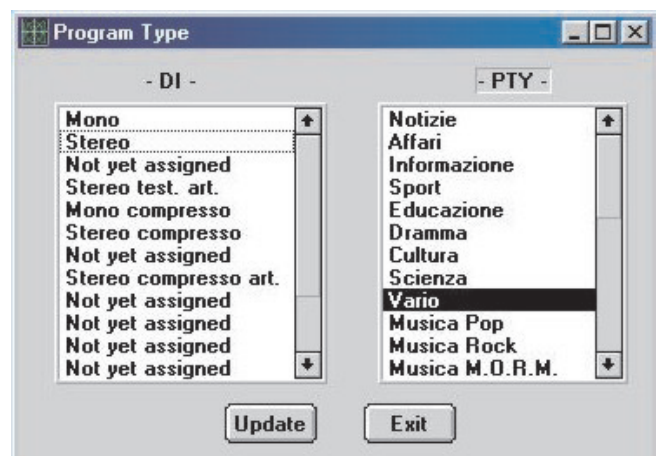

3.4.10. **TA-TP-MS**
RDS Encoder
Programming

At any time during the day, the broadcaster can interrupt the programme being transmitted with traffic news; for this reason the standard provides for a number of flags which indicate to the receiver that this information is being transmitted so that automatic tuning and/or volume adjustment can be made. These flags are named TA, TP and MS.

- ✓ The TP flag identifies the broadcaster which is making traffic announcements
- ✓ The TA defines the time intervals between traffic announcements.
- ✓ The MS flag indicates whether the transmission is of Music or Speech (Voice)

These flags can be set by clicking the mouse on the relevant keys or via a remote keyboard connected to the appropriate board connector. If the remote keyboard is connected, the "Remote" key will be lit green and setup via a PC will be inhibited.

If the colour of the TA, TP and MS keys do not agree with the encoder leds immediately above, this means that the flags set on the screen do not match those of the encoder. To update them press the Update key.

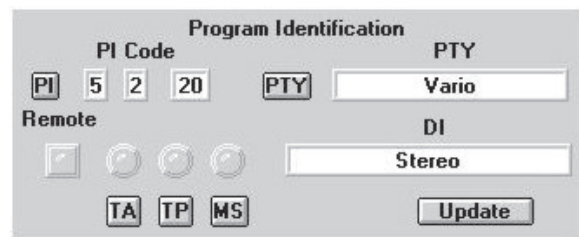

Radio Text

Radio Text is a message with a maximum length of 64 characters used to check the quality of the signal within the coverage area. The message is transmitted indefinitely

To program the message, click the mouse on the RTEXT key.
To activate the message, click the mouse on the adjacent ON/OFF key.



3.4.10. **EON Message**
RDS Encoder
Programming

The EON message is used when a broadcaster has an agreement with another broadcaster (that we shall call "Friend") to permit automatic tuning of receivers to Radio Friend, in areas where the signal quality of the broadcaster is poor or absent, or when Radio Friend is broadcasting information of interest to the listener.

RDS allows programming of data upto a maximum of 8 partner broadcasters. Each broadcast network is a broadcaster in its own right and must therefore have unique identification of its data and allow all common services of interest identifiable between the two broadcasters.



Programming access to all this data is enabled by clicking the EON key located on the left side of the main panel; this displays the list of 8 networks that can be programmed.

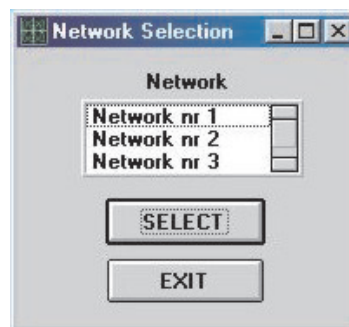

Having chosen a network, a screen is displayed which shows all the parameters to be programmed: PI-PS-TA-TP-PTY-AF-PIN

- ✓ PI is the identification code of radio Friend.
- ✓ PS is the 8 character message which is displayed on receivers tuned to the radio Friend frequencies.
- ✓ TP indicates that the Friend broadcaster is enabled to transmit traffic news.
- ✓ TA indicates that the Friend broadcaster is transmitting traffic announcements.
- ✓ PTY indicates the type of programme.
- ✓ AF indicates the list of alternative frequencies on which radio Friend can be received.

3.4.10. RDS Encoder Programming

The method of programming is similar to that of the main broadcaster (see previous pages). For each network it is possible to program a maximum of 7 frequencies with method A and 4 frequencies with method B.

To enable transmission of the programmed data for each network, just press the "Message Active" key; if it is coloured green, this means that the data is valid and may be transmitted.

ATTENTION: data relating to active networks (those for which the "Message Active" is green) are transmitted even if the ON/OFF key on the main panel is set (green).

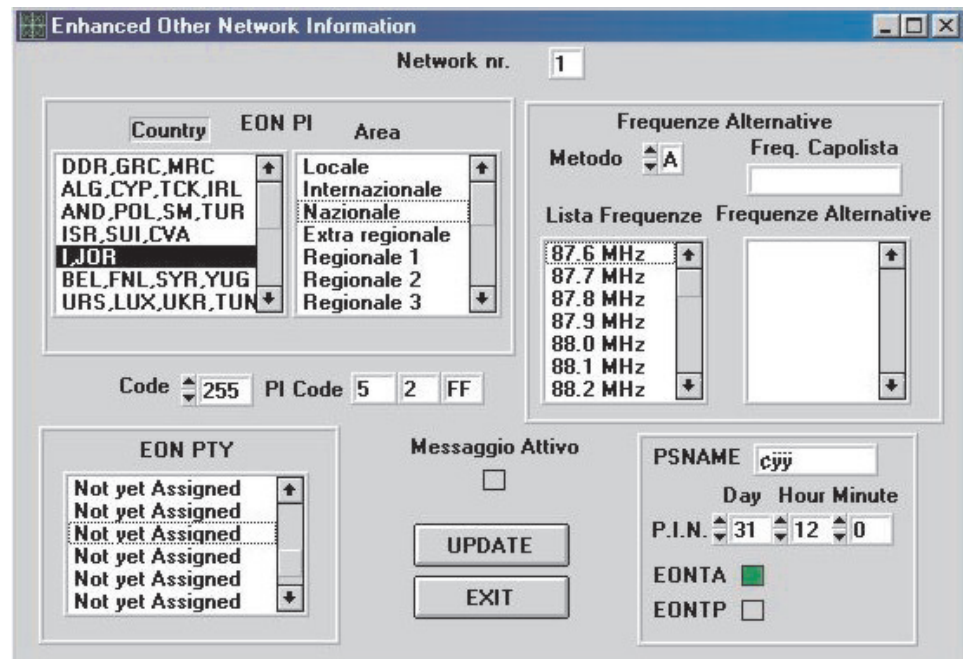

Time & Clock Data

The RDS encoder has an on-board clock-calendar which provides an autonomous timing function. The clock-calendar can be read and updated so that listener's receivers can be synchronised. When this message is transmitted, the encoder sends a data packet containing the date and time referred to the Greenwich meridian on every change of minute. The time difference is expressed in half-hour steps.

To synchronise the clock-calendar to the actual date and time:

1. Press the CLOCK key or the TIME&C key

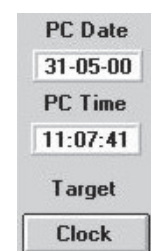

3.4.10.
RDS Encoder
Programming

2. Double-click on the TARGET TIME box and enter the time local to where the broadcaster is transmitting.
3. Double click on the TARGET DATE box and enter the date.
4. Select the location with respect to Greenwich (the RDS system is able to update the time according to the country in which it is transmitting).
5. Press the UPDATE key to transfer the data to the encoder.

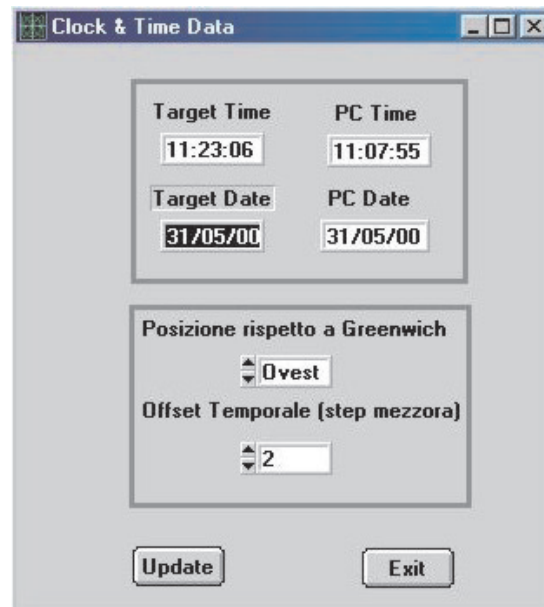

If the EXIT key is pressed, the clock-calendar will not be changed.



Once the programming is complete, the PC can be disconnected and used for other purposes. Clicking the mouse on the EXIT key will terminate programming of the encoder.

3.4.10.
RDS Encoder
Programming

Technical data

| | |
|--------------------------|--|
| RDS SIGNAL..... | as per CENELEC EN50067 |
| ENCODING..... | 2 level differential |
| MODULATION..... | DSB suppressed carrier |
| FREQUENCY..... | 57 KHz..... |
| BAND..... | +/- 2.4 KHz |
| INPUT MPX..... | 0/+12 dBm into 600 Ohms |
| OUTPUT..... | MPX+RDS |
| MPX OUTPUT LEVEL..... | Inp. MPX..... |
| RDS OUTPUT LEVEL..... | 20 - 150 mV RMS |
| OUTPUT IMPEDANCE..... | 100 Ohms..... |
| PS MESSAGES | 8 with 16 words of 8 characters..... |
| ALTERNATIVE | 16 with maximum 250 frequencies each |
| FREQUENCY LISTS | |
| MESSAGE..... | With IBM compatible PC |
| PROGRAMMING | |
| CONNECTION | RS232-C Standard |
| COMMUNICATION..... | Full Duplex..... |
| SPEED..... | 2400 baud |
| CONNECTORS | 9 Pin Cannon Female |
| | 9 Pin Cannon Male |
| | BNC..... |
| MESSAGE MANAGEMENT | Microcontroller..... |
| DATA BACKUP | 10 years |
| OPERATING TEMPERATURE... | 0 - 55 °C..... |
| POWER SUPPLY | +12Vdc 100mA, +5Vdc 800mA |

3.5. *Checking performance*

This procedure for checking performance should be carried out if there is any doubt over the integrity of the unit or possible damage sustained during transport. It should be performed by expert personnel capable of operating radiofrequency measurement equipment.

The unit is calibrated using an FMAB modulation analyser (R&S) and so the performance checking equipment must be high precision, analogue instrumentation.

Power developed Connect a high quality wattmeter (e.g. Bird mod. 43) to the unit, via a double, male N-type connector. The wattmeter output is connected to a high quality dummy load (SWR less than 1.05) capable of dissipating at least 500W continuously via a 50 Ohm coaxial cable of appropriate cross section (e.g. RG213). Adjust the maximum range of the wattmeter to correspond to the power generated (e.g. for a Bird mod. 43 wattmeter, use a 500W probe adjusted to measure direct power). Power up the unit and check that the power shown on the display corresponds to the power displayed by the wattmeter. There is a tolerance of upto 25W difference between the two.
It is of the utmost importance to use a wattmeter that is performing to its high precision specification.
The measurement will be invalid if the wattmeter is connected to the unit via a coaxial cable without the double connector as specified.

Programmed frequency Connect the unit to a dummy load with a -30dB output capable of dissipating at least 500W of continuous power, via a 50 Ohm coaxial cable of appropriate section (e.g. RG213). Connect the output of the dummy load, attenuated by another 20dB, to a frequency meter which is known to be performing to its high-precision specification. Power up the unit and check that the frequency shown on the display corresponds to the frequency displayed by the frequency meter. There is a tolerance of upto 100Hz difference between the two readings.

Deviation Connect the unit to a dummy load with a -30dB output capable of dissipating at least 500W of continuous power, with a coaxial cable of appropriate section (e.g. RG213). Connect the output of the dummy load, attenuated by another 20dB to a modulation analyser which is known to be performing to its high-precision specification. Connect the MPX input to a 1KHz sinusoidal signal from a low-frequency signal generator, with the amplitude adjusted for a level of 0dBm. Power up the unit and check that the deviation displayed by the unit and by the modulation analyser fall within the range 75KHz -0.2dB and 75 KHz.

4.1.
Introduction



This technical manual contains information regarding the operation, use and maintenance of the ETG250 (ETG300) exciter.

The ETG250 (ETG300) operates in the frequency band from 87.5MHz to 108MHz in steps of 10KHz and is capable of developing a maximum, continuous power of 250W (300W).

All the operating controls of the unit are directly accessible from the front panel whilst all the connectors are available on the rear panel.

The connectors for measurement of signals are however located on the front panel.

The exciter can be used for monophonic, stereo and composite multiplex transmissions.

The ETG250 (ETG300) exciter is available in two versions which are identical from an operational point of view but have different power supply circuitry.

4.2.
Using the
block diagram

The block diagrams describing the two versions of the ETG250 (ETG300) exciter are on the following two pages.

The principle of communication between the various boards is clear from their interconnection; each connection is identified by a progressive number within a circle. In the pages following the block diagram where individual boards are described, the cable loom numbers are identified in order to simplify maintenance and eventual repair.

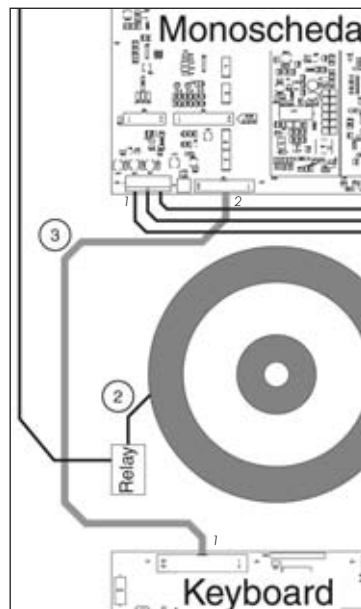

In this case, for example, the board is connected to the keyboard via flat 3, and the transformer is connected to the relay via cable 2 etc.

In the board descriptions following the block diagram, the following information appears:

Connections:

- 1 (JD1) via cable flat 3 to 1 (J1) of the monoboard

The first number is a reference whilst the number in brackets represents the name of the connector of the board in question.

For more detail, see the layouts of the schematics.

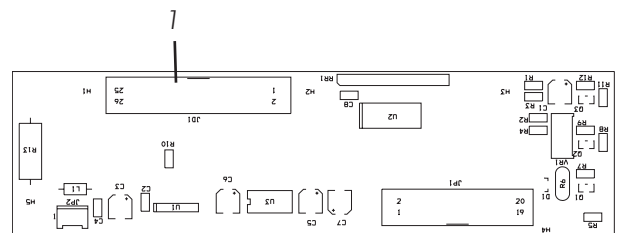

Pag 1 file A3

Pag 2 file A3

4.4.
Power supply section

The ETG250 (ETG300) uses a switch-mode converter in the transformer version and a switch-mode power supply connected direct to the line supply in the other version (DR).

The section which supplies power to the services is the same for both versions. The ETG250 (ETG300) exciter features, on both versions, a line filter fitted to the alternating supply to provide maximum suppression of conducted interference. The use of discrete component technology enables easy replacement in the event of failure.

4.4.1.
Service power supply

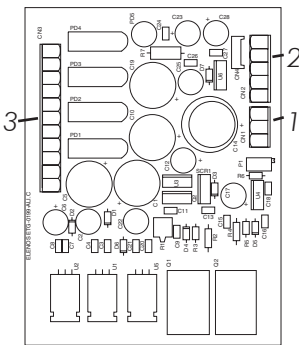

The service (or auxiliary) power supply furnishes 5 separate supplies which supply the various boards which go to make up the unit.

The table below summarises the supply voltages for each section of the unit and the corresponding protection.

The service (or auxiliary) power supply is a linear type in order to reduce to a minimum any disturbances that could interfere with the boards.

| Supply Voltage | Boards supplied | Protection |
|--------------------|---------------------------------|--------------------------------|
| +12V | Mother board (CPU, PLL, BUS) | Current protection |
| -12V | Mother board (CPU, PLL, BUS) | Current protection |
| +5V | Mother board (CPU, PLL, BUS) | Current and voltage protection |
| +12V _{RF} | RF driver stage | Current protection |
| +18V _{RF} | RF driver stage | Current protection |

Connections:

- 1 (CN1) via cable 13 to 2 to the "DRIVER" board
- 2 (CN2) via cable 4 to 1 (J1) of the mother board
- 3 (CN3) via cable 7 to the transformer

4.4.2.
Switch-mode power supply (DR version)



Supplies a variable voltage from +30V to +50V, with current and voltage protection. It uses a mix of SMD and traditional technology to reduce the space occupied as far as possible.

The power supply features thermal protection and a further line filter equipped with VDRs on the input.

Connections:

(only in the switch-mode DR version)

- 1 via cable 2 to the relay
- 2 via cable 5 to 1 (J1) of the mother board
- 3 via cable 18 to 3 of the RF modules

4.4.2.2. Transformer power supply

Supplies a variable voltage from +20V to +50V with voltage and current protection. Uses traditional technology to facilitate replacement of faulty parts. The power supply also features thermal protection and both input and output filters in order to minimise interference.

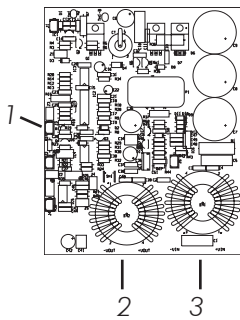

Connections:

(Only for the transformer version)

- 1 via cable 5 to 1 (J1) of the mother board
- 2 via cable 18 to 3 of the RF modules
- 3 via cable 19 to 1 (J1) of the mother board

4.5. Radiofrequency section

This comprises a low power output stage (driver) which, via a splitter, supplies the power to the two final power stages.

The power output from the modules supplies a coupler (or output adder) which concentrates all the power to the input of the low-pass filter.

The measurement probe which is located on the final part of the low-pass filter, reads the values of direct and reflected power for the CPU.

4.5.1. Driver

The driver comprises an input stage of about 10mW and supplies a maximum output power of 15W.

It is built using a mix of technologies and subdivided into three main amplifying stages.

The first stage is a "MMIC" type "ERA5".

The second stage is a MOS BLF404.

The third stage is a MOS BLF244.

The output of the driver is connected to the input splitter.

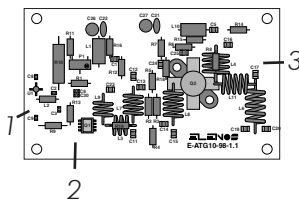

Connections:

- 1 via coaxial cable 10 to 3 (J8 RF OUT) of the mother board
- 2 via cable 13 to 1 (CN1) of the services power supply (auxiliary)
- 3 via coaxial cable 14 to 1 of the input splitter (Splitter IN)

4.5.2.
RF Modules

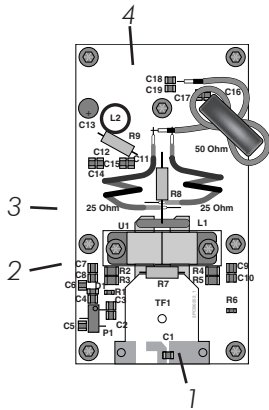

The two modules comprise a MOSFET (BLF278) and are capable of delivering a maximum power of 300W each.

The gates are controlled by the CPU so that power output can be inhibited when the user changes frequency.

The outputs of both modules enter the couple (or output combiner).

Connections:

- 1 via coaxial cables 15 and 16 to 2 and 3 of the input splitter (Splitter IN)
- 2 via cable 6 to 1 (J1) of the mother board
- 3 via cable 18 to 2 of the power supply (this is dependant on the version of power supply)
- 4 via coaxial cable 17 to 2 of the low-pass filter (LPF INPUT)

4.5.3.
Low-pass filter

RF Out

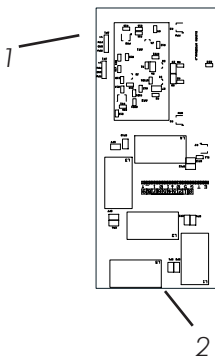

This is a ninth order "CHEBYCHEV" filter, with teflon support. It guarantees the suppression of harmonic components with the limits set by International standards.

Connections:

- 1 (JP1) via flat cable to 5 (CN1) of the mother board
- 2 via coaxial cable 17 to 4 of the RF Modules

"RF Out" indicates the RF power output connector which is located on the rear panel

4.5.4.1.
Directional coupler
Output power
measurement

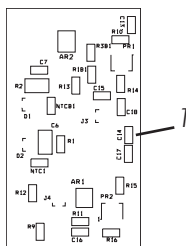

The directional coupler is located on the final output stage of the low-pass filter. It is designed using SMD technology and is shielded to prevent RF interference. It generates a voltage proportional to the direct and reflected power.

Connections:

- 1 (JP1) via flat cable 11 to 5 (CN1) of the mother board

N.B.

The directional coupler is mounted on the same circuit board.

4.5.4.2.
Directional coupler
AGC protection

A control circuit regulates the output power and maintains it to within +0.1dB across the whole operating band, progressively reducing it down to 50W in the event of excessive SWR. This enables the exciter to continue to work with infinite SWR at any phase angle.

4.6. Logic (Mother board)

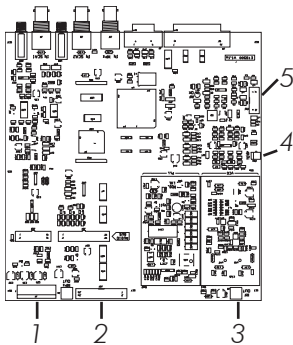

This board is constructed using only SMD technology and comprises the following stages:

- CPU
- AGC
- VCO/PLL
- MPX

Connections:

- 1 (J1) via cable 4 to 2 (CN2) of the services (auxiliary) power supply
- 1 (J1) via cable 5 to 1 of the power supply (dependant on the version)
- 1 (J1) via cable 6 to 2 of the RF Modules
- 2 (JD1) via cable flat to 1 (JD1) of the Keyboard
- 3 (SC1) via coaxial cable 10 to 1 of the Driver
- 4 (CN2) via cable 12 to the temperature sensor
- 5 (CN1) via cable flat 11 to 1 of the directional coupler

4.6.1. CPU

The CPU controls the display, the keyboard, ALC and the VCO/PLL. It comprises an 80C552 microprocessor which operates at a clock rate of 16MHz.

It features a 256 Kbit RAM and a 2Mbit ROM.

It receives input signals from the directional coupler and supplies processed signals to the ALC.

It also controls all the audio functions.

4.6.2. ALC

This receives signals from the CPU and supplies 2 output voltages:

- 1) Controls the MOS gates
- 2) Controls the output voltage of the power supply.

It features SWR protection which limits the output power in the event of an SWR in excess of the programmed threshold.

4.6.3. VCO/PLL

The PLL board generates the frequency-modulated RF signal using phase-lock synthesis.

The oscillator, controlled by the VCO voltage and mounted next to the PLL board, uses very low-noise components and also separation stages to obtain very low phase noise.

The reference frequency is generated by a temperature-compensated oscillator with a maximum drift of 1 ppm.

4.6.4. MPX

Accepts the wide-band MPX input signal, i.e. it supplies the transmitter with a stereo signal derived from an external stereo encoder. It features 2 SCA inputs, one of which can be used as an RDS data input.

The two unbalanced inputs for SCA signals accept input frequencies upto 200 KHz. The MPX also supplies the microcontroller with an appropriately processed MPX signal so that the level can be displayed as a bar graph and in dBV values. The inputs are protected against over-voltage.

The inputs are unbalanced on BNC connectors (impedance 10KOhm).

4.7. Keyboard

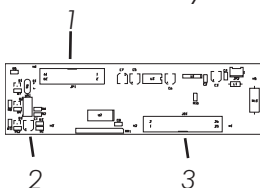

This is interfaced to the CPU and supplies signals to the display as well as power for illumination.

A trimmer allows adjustment of the contrast.

8 soft keys perform functions shown on the display.

Connections:

- 1 (JP1) via flat cable 3 to 2 (JD1) of the mother board
- 2 via cable 8 to the display
- 3 (JD1) via flat cable 9 to the display

4.8. *Optional boards* The optional boards offer extra facilities required by customers and are simply fitted by inserting them into the relevant slots, described on page 7 of this manual, with the unit switched off.

4.8.1. *Stereo Input Board*

This board comprises two modules:
- Inputs
- Clipper
Inserted into the slot indicated on page 7, it has the function of processing the audio signal for stereophonic transmission. The board also supplies the processed stereo signal to the microcontroller which displays stereo levels using a bar graph and values expressed in dBu. The input connectors are balanced, XLR type (see the connection diagram below).

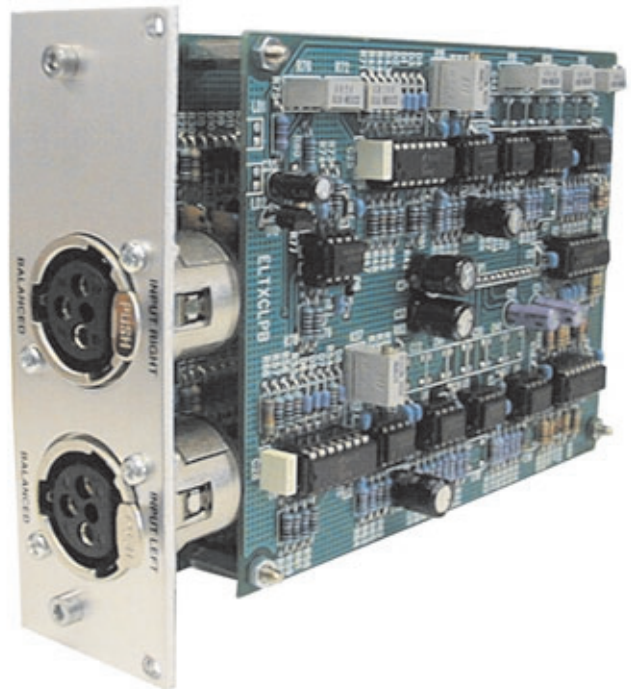

- Adjustments:
- ☞ selection (jumper) of the value of pre-emphasis (50/75 usec)
 - ☞ ON/OFF (jumper) of pre-emphasis
 - ☞ ON/OFF (software) of pre-emphasis, of the clipper and of the filter
 - ☞ adjustment (software) of the level in steps of 0.5dB on each channel
 - ☞ selection (jumper) of the input impedance value (600Ohm/10KOhm)

Linea bilanciata

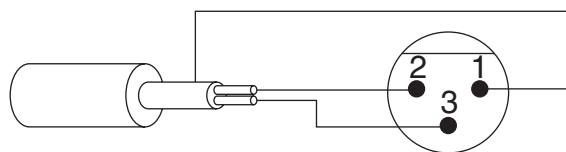

- Piedino 1: massa
- Piedino 2: positivo
- Piedino 3: invertente

Linea sbilanciata

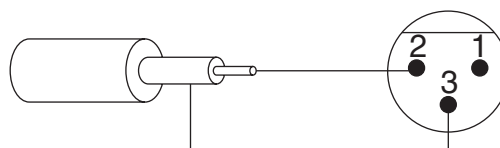

4.8.2. Stereo Encoder Board

This board digitally generates the 19 KHz pilot carrier and the suppressed carrier. It fits in the slot indicated on page 7. It features a BNC connector for supplying the signal to other transmitters.



Adjustments:

- ✎ adjustment (trimmer) of the pilot tone (8-12%)
- ✎ adjustment (trimmer) of the MPX signal clipper threshold before being added to the pilot carrier
- ✎ ON/OFF (jumper) of the clipper
- ✎ adjustment (trimmer) of the MPX level on the output of the board
- ✎ adjustment (trimmer) of the phase of the pilot tone with respect to the suppressed carrier
- ✎ adjustment (2 trimmers) of the equaliser of the sum of the signals (L+R) to obtain maximum separation
- ✎ adjustment (trimmer) of the suppressed carrier level (greater than 90 dB)
- ✎ ON/OFF (software) of the clipper
- ✎ ON/OFF (software) of the pilot carrier
- ✎ selection (software) stereo/mono

Technical data

| | |
|------------------------|--|
| PRE-EMPHASIS | 50/75 us +/-0.1dB |
| FREQUENCY RESPONSE | +/-0.15dB (30Hz - 15KHz) |
| STEREO SEPARATION | typically 65dB @ 1KHz |
| PILOT TONE | Frequency: 19KHz +/- 1Hz deviation 7.5KHz adjustable |
| AUDIO INPUT MODULE L/R | Input impedance: 10KOhm - 600Ohm (selectable) balanced input Frequency response: 20Hz - 15KHz Adjustment: -12 - +12dB in steps of 0.1dB Connector: XLR female |
| ATTENUATION AT 19KHz | 45dB |

4.8.3. RDS Board

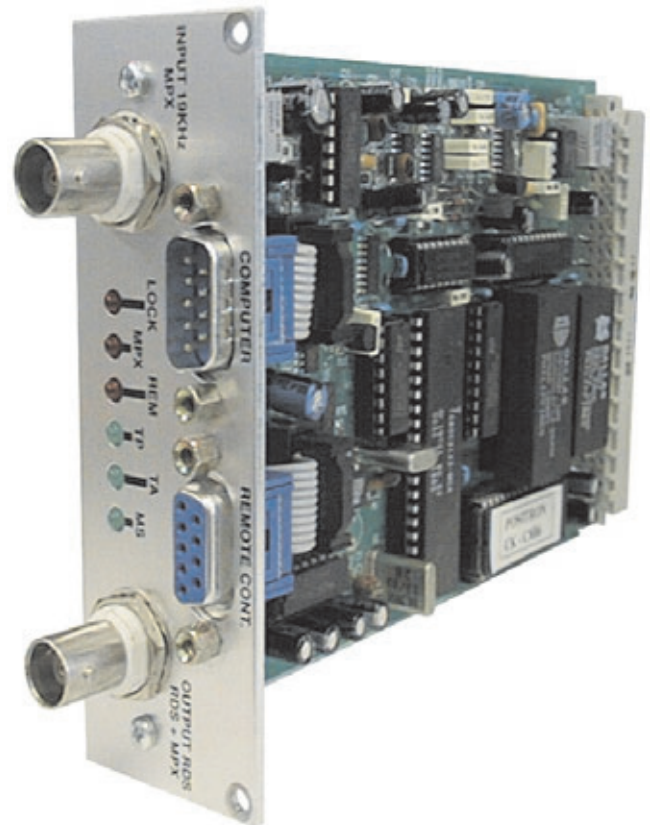

Introduction

For several years now, within the field of radio broadcasting, the importance of transmitting data packets of various types, over and above the radio signal, has been recognised as crucial to improving the quality and reliability of the services offered, let alone implementing new ones.

This need was acknowledged at international level and a study group was given a mandate to identify the various needs and define a transmission standard which is suitable for the sector.

The group created the RADIO DATA SYSTEM (RDS) which is now the most diffuse system of data transmission in the radiophonic sector.

The optional RDS board fits in the slot indicated on page 7 of this technical manual.

The ETG250 (ETG300)'s optional RDS board allows a data channel to be transmitted alongside the radiophonic signal (mono or stereo), in conformity with the "Specification of the radio data system (RDS)" document, published by the European Committee for Electrotechnical Standardization (CENELEC) Ref. NO. EN50067:1990.

RDS system

The RADIO-DATA-SYSTEM (RDS) has been specified for the transmission of information within mono/stereophonic programmes in the VHF/MF (87.5-108MHz) band, thus satisfying the requirements for transmission of additional data in radiophonic programmes.

- > Compatibility with actual mono/stereophonic programmes
- > Absence of interference between adjacent channels
- > Compatibility with other existing systems of identification

4.8.3. RDS board

The system, selected by an international working group of specialists, allows data transmission at a speed of 1187.5 bit/sec with phase modulation at two levels, 57KHz carrier and band +/- 2KHz. The transmitted binary signal undergoes differential encoding.

The transmission protocol comprises packets of 104 bit (87.6ms) length, named GROUPS, each comprising 4 BLOCKS of 26 bits each. Each BLOCK is made up of 16 bits of information and 10 protection bits, designed specifically to allow words to be corrected upto a maximum of 5 bit in error. 16 distinct GROUPS are provided, some of which have not yet been defined. Each group starts with an identification code (PI) which has the double scope of synchronising the receiver and identifying the broadcaster that is transmitting the signal. The PI comprises a 4 bit code to identify the country (Italy is code 5), a 4 bit code to define the coverage of the transmitted signal (International, National, Sub-National, Regional or Local) and an 8 bit code for the number of reference of the program.

The Zero GROUP is used for sending the PS message (shown on the display of RDS compatible receivers) and for tuning frequencies. Each Zero group contains 2 characters of the message, two tuning frequencies, a code which defines the type of transmission (mono, stereo, compressed, etc.), a bit to define whether music or speech is being transmitted and a code for signalling the transmission of traffic news.

Two formats are provided for the transmission of alternative frequencies:

- A) Each station transmits a unique list of frequencies, preceded by the number of frequencies that it contains (max 25);
- B) Each station transmits a unique list of frequencies for each transmitter that it possesses. The list begins with the header frequency, followed by the frequencies (max 12) used by adjacent transmitters in the coverage area. This method is more efficient when the list of frequencies is long because it presents the self-tuning system with fewer frequencies to choose from and thus speed up the process of searching for new frequencies. If the number of frequencies is low, mode A is advised as it requires less data to be transmitted.

RDS system

The RDS encoder comprises a single Euro card offering the following features:

- ✓ Connector 41612 which accepts the power supply voltages +5V and +12V
- ✓ BNC for the input of the mono or stereo signal
- ✓ BNC for the output of the MPX signal and/or MPX+RDS
- ✓ Cannon connector 9 PIN for serial connection to a PC
- ✓ Cannon connector 9 PIN for connection of a remote keyboard
- ✓ A panel-mounted trimmer for adjusting the RDS signal level
- ✓ Led indicator, for lock and carrier generation RDS (LOCK)
- ✓ Led indicator, for synchronisation with stereo carrier (STEREO)
- ✓ Led indicator for remote control active (REM)
- ✓ Led indicator for TP set (TP)
- ✓ Led indicator for TA set (TA)
- ✓ Led indicator for MS set (MS)



4.8.3.
RDS board

The board is equipped with DB25-type female to DB9-type male cable, which can be replaced by a DB9 female to DB9 male cable (see diagram below), plus a 3.5" floppy with software for correctly programming the RDS.

N.B.
The software supplied is Microsoft Windows (c) compatible.

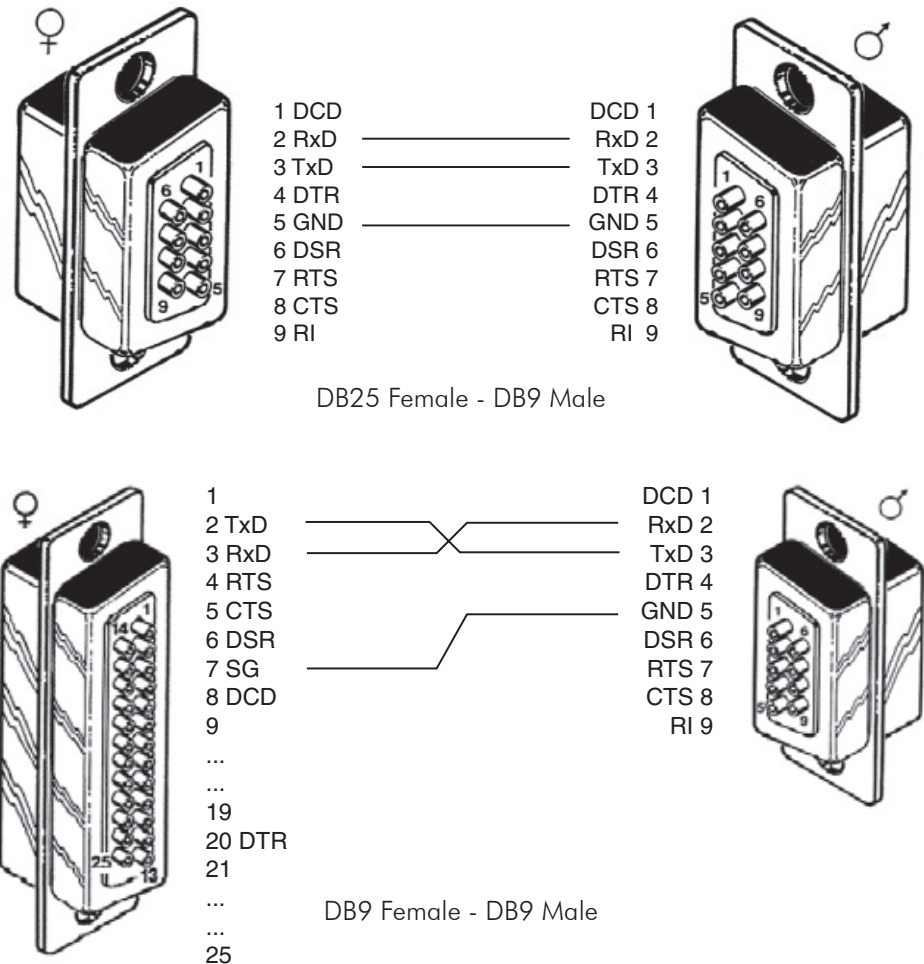

The board features a microcontroller which controls the RDS message generation.

The services supported by the encoder are programmed via a PC connected to the serial interface, running an easy-to-use program. Once programmed, the RDS messages are saved, even in the absence of primary power.

The board is equipped with a timer-calendar which updates the date and time even when no external power is present.

The RDS carrier is generated internally by a quartz oscillator, but when a 19KHz carrier is applied to the MPX1 IN input, whose amplitude, stability and frequency conform with the specification, the encoder locks to the external frequency and generates the 57 KHz synchronised to it (STEREO led lit). Thanks to the microcontroller, the encoder can modify the transmitted message in real time which makes the system extremely flexible and adaptable to the various customer requirements.

The software supplied allows programming of a set of 8 distinct PS Messages each comprising 16 words of 8 characters and a maximum of 16 lists of alternative frequencies. These limits are not binding but have been advised by a sample of users.

4.8.3.
RDS board

The set of messages can be put on-air automatically at any hour of the day. Programming of the messages is very quick and easy; an entire message can be programmed in one minute. No special knowledge is necessary on the part of the user.

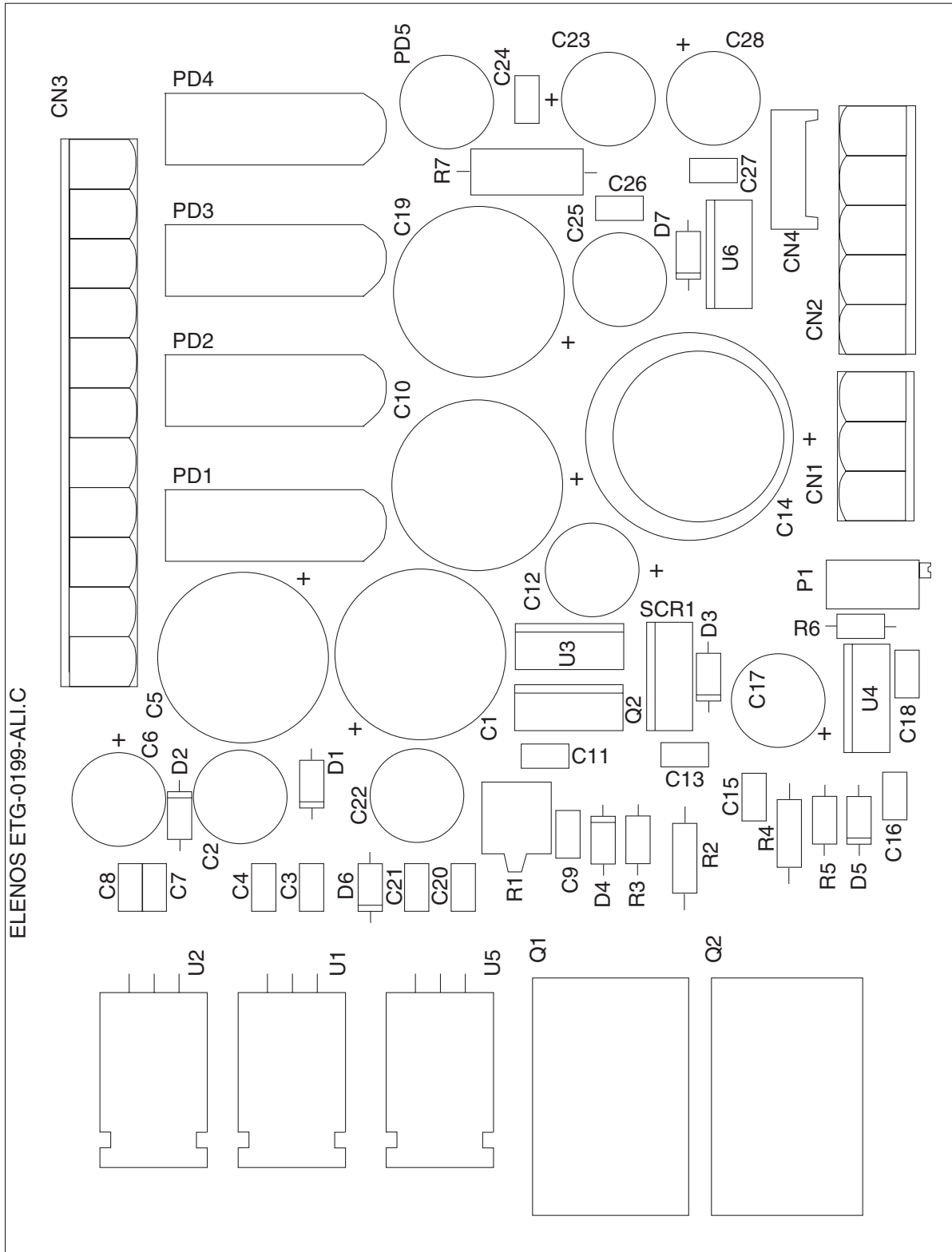

| | | | | | |
|---|--|--------------------------|---|-----------------|--|
| ELENOS | | | Via G. Amendola 9 44028 Poggio Renatico (FE) Italy Tel +39 0532 829965 Fax +39 0532 829177 Website WWW.ELENOS.COM | | |
| Title: AUX POWER SUPPLY | | | | | |
| Board Code: ETG-0199-ALI.C | | Model: ETG250/300 | | Rev 1 | |
| Proj. Engr. : A. Tomassini | | | Approved : A. Giovannelli | | |
| Date: Wednesday, November 15, 2000 | | | Sheet 1 of 1 | | |

Pag 3 file A3

Parts list

| Ref. | Description |
|------|-------------------|
| CN1 | WIELAND 3 M V |
| CN2 | WIELAND 5 M V |
| CN3 | HEADER 11 |
| CN4 | AMP MODUII 4 M V |
| C1 | CEV 4700uF 35V |
| C5 | CEV 4700uF 35V |
| C10 | CEV 4700uF 35V |
| C19 | CEV 4700uF 35V |
| C2 | 100nF 50V CER. |
| C2 | CEV 100uF 63V |
| C6 | CEV 100uF 63V |
| C12 | CEV 100uF 63V |
| C17 | CEV 100uF 63V |
| C22 | CEV 100uF 63V |
| C3 | CMY 0.1uF 63V |
| C4 | CMY 0.1uF 63V |
| C7 | CMY 0.1uF 63V |
| C8 | CMY 0.1uF 63V |
| C9 | CMY 0.1uF 63V |
| C11 | CMY 0.1uF 63V |
| C13 | CMY 0.1uF 63V |
| C15 | CMY 0.1uF 63V |
| C16 | CMY 0.1uF 63V |
| C18 | CMY 0.1uF 63V |
| C20 | CMY 0.1uF 63V |
| C21 | CMY 0.1uF 63V |
| C14 | CEV 2200uF 63V |
| D1 | DIODE 1N4007 |
| D2 | DIODE 1N4007 |
| D4 | DIODE 1N4007 |
| D5 | DIODE 1N4007 |
| D6 | DIODE 1N4007 |
| D3 | BZX85C5V6 |
| HOL1 | CONNECTOR SCREW |
| HOL2 | CONNECTOR SCREW |
| HOL3 | CONNECTOR SCREW |
| HOL4 | CONNECTOR SCREW |
| PD1 | BRIDGE KBU8K |
| PD2 | BRIDGE KBU8K |
| PD3 | BRIDGE KBU8K |
| PD4 | BRIDGE KBU8K |
| P1 | RES. 67X 10K |
| Q1 | BC337 |
| Q1 | TIP34C |
| Q3 | TIP34C |
| Q2 | BD140 |
| R1 | RES. 0.22R 5W 5% |
| R1 | 22K 0.25W 5% |
| R4 | RES. 18R 0.5W 5% |
| R2 | RES. 18R 0.5W 5% |
| R3 | RES. 22R 0.25W 5% |
| R5 | RES. 1K 0.25W 5% |
| R6 | RES. 12K 0.25W 5% |
| SCR1 | TIC216M |
| U1 | LM7812CT |

Parts list

| Ref. | Description |
|------|-------------|
| U2 | LM7912CT |
| U3 | LM7805CT |
| U4 | LM317 |
| U5 | UA7812 |

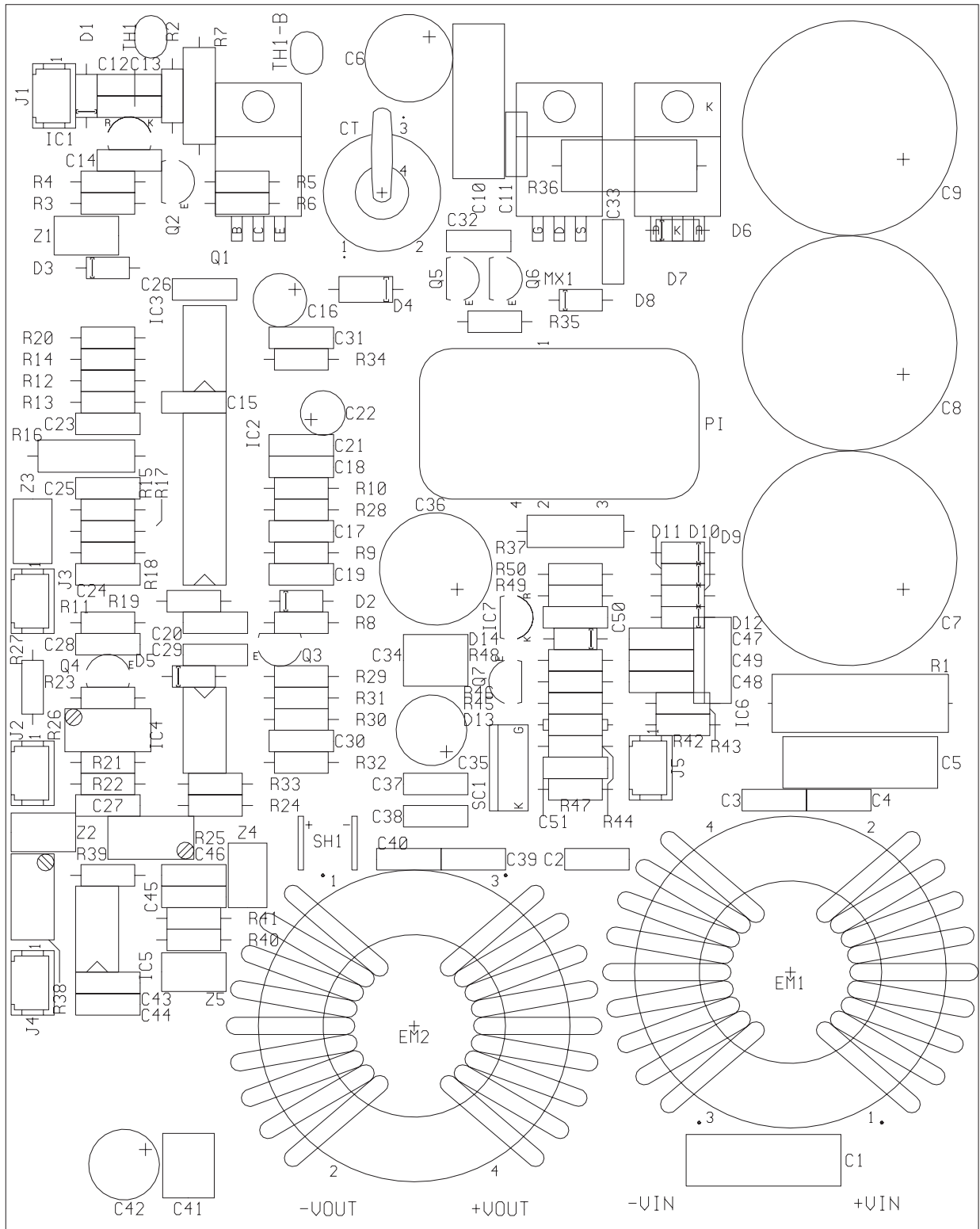

| | | | |
|--|------------------------------|---|--------------|
|  | | Via G.Amendola 9 44028 Poggio Renatico (FE) Italy | |
| | | Tel +39 0532 829965 Fax +39 0532 829177 Website WWW.ELENOS.COM | |
| Title: SWITCHING CONVERTER | | | |
| Board Code: | E13-98AA-ALI.B | Model: | ETG250/300 |
| Proj. Engr. : | A.Tomassini | Approved : | A.Giovanelli |
| Date: | Wednesday, November 15, 2000 | Sheet | 1 of 1 |

Pag 4 file A3

Parts list

| Ref. | Description |
|------|---------------------------------------|
| R1 | 4,7K Resistenza a filo cassa ceramica |
| R2 | 39K Resistenza strato di carbone |
| R3 | 30,1K Resistenza strato metallico |
| R4 | 5,11K Resistenza strato metallico |
| R5 | 6,8K Resistenza strato di carbone |
| R6 | 4,7R Resistenza strato di carbone |
| R7 | 10K Resistenza ossidi metallici |
| R8 | 1K Resistenza strato di carbone |
| R9 | 4,22K Resistenza strato metallico |
| R10 | 150K Resistenza strato di carbone |
| R11 | 8,2K Resistenza strato di carbone |
| R12 | 3,3K Resistenza strato di carbone |
| R13 | 15K Resistenza strato di carbone |
| R14 | 8,2K Resistenza strato di carbone |
| R15 | 1K Resistenza strato di carbone |
| R16 | 2,7R Resistenza ossidi metallici |
| R17 | 365K Resistenza strato metallico |
| R18 | 10K Resistenza strato metallico |
| R19 | 1K Resistenza strato di carbone |
| R20 | 22K Resistenza strato di carbone |
| R21 | 10K Resistenza strato metallico |
| R22 | 1K Resistenza strato metallico |
| R23 | 10K Resistenza strato di carbone |
| R24 | 100R Resistenza strato metallico |
| R25 | 500R Trimmer verticale multigiri |
| R26 | 5K Trimmer verticale multigiri |
| R27 | 4,22K Resistenza strato metallico |
| R28 | 30,1K Resistenza strato metallico |
| R29 | 4,7K Resistenza strato di carbone |
| R30 | |
| R31 | 10K Resistenza strato di carbone |
| R32 | 90,9K Resistenza strato metallico |
| R33 | 10K Resistenza strato metallico |
| R34 | 220R Resistenza strato di carbone |
| R35 | 10R Resistenza strato di carbone |
| R36 | 15R Resistenza ossidi metallici |
| R37 | 4,7K Resistenza ossidi metallici |
| R38 | 50K Trimmer verticale multigiri |
| R39 | 10K Resistenza strato metallico |
| R40 | 1K Resistenza strato metallico |
| R41 | 1K Resistenza strato metallico |
| R42 | 1,96K Resistenza strato metallico |
| R43 | 226R Resistenza strato metallico |
| R44 | 100R Resistenza strato di carbone |
| R45 | 2,2K Resistenza strato di carbone |
| R46 | 2,2K Resistenza strato di carbone |
| R47 | 100K Resistenza strato di carbone |
| R48 | 330R Resistenza strato di carbone |
| R49 | 86,6K Resistenza strato metallico |
| R50 | 4,22K Resistenza strato metallico |
| TH1 | Termistore PTC:PTH9M04BF222TS2F333 |
| C1 | 1uF Cond. Poliestere scatolino |
| C2 | 22nF Cond. Ceramico multistrato |
| C3 | 22nF Cond. Ceramico multistrato |
| C4 | 22nF Cond. Ceramico multistrato |

Parts list

| Ref. | Description | |
|------|-------------|------------------------------------|
| C5 | 1uF | Cond. Poliestere scatolino |
| C6 | 47uF | Cond. Elettrolitico verticale 105° |
| C7 | 1000uF | Cond. Elettrolitico snap-in 85° |
| C8 | 1000uF | Cond. Elettrolitico snap-in 85° |
| C9 | 1000uF | Cond. Elettrolitico snap-in 85° |
| C10 | 1uF | Cond. Poliestere scatolino |
| C11 | 100nF | Cond. Ceramico multistrato |
| C12 | 100nF | Cond. Ceramico multistrato |
| C13 | 1uF | Cond. Ceramico multistrato |
| C14 | 100nF | Cond. Ceramico multistrato |
| C15 | 1uF | Cond. Ceramico multistrato |
| C16 | 47uF | Cond. Elettrolitico verticale |
| C17 | 1uF | Cond. Ceramico multistrato |
| C18 | 330pF | Cond. Ceramico multistrato |
| C19 | 1nF | Cond. Poliestere scatolino |
| C20 | 10nF | Cond. Ceramico multistrato |
| C21 | 100nF | Cond. Ceramico multistrato |
| C22 | 10uF | Cond. Tantalo a goccia |
| C23 | 10pF | Cond. Ceramico a disco |
| C24 | 100nF | Cond. Ceramico multistrato |
| C25 | 100pF | Cond. Ceramico multistrato |
| C26 | 100nF | Cond. Ceramico multistrato |
| C27 | 1uF | Cond. Ceramico multistrato |
| C28 | 100nF | Cond. Ceramico multistrato |
| C29 | 100nF | Cond. Ceramico multistrato |
| C30 | 2,2nF | Cond. Ceramico multistrato |
| C31 | 100nF | Cond. Ceramico multistrato |
| C32 | 100nF | Cond. Ceramico multistrato |
| C33 | 2,2nF | Cond. Ceramico alta tensione |
| C34 | 1uF | Cond. Poliestere scatolino |
| C35 | 22uF | Cond. Elettrolitico verticale 105° |
| C36 | 220uF | Cond. Elettrolitico verticale 105° |
| C37 | 1uF | Cond. Ceramico multistrato |
| C38 | 100nF | Cond. Ceramico multistrato |
| C39 | 22nF | Cond. Ceramico multistrato |
| C40 | 22nF | Cond. Ceramico multistrato |
| C41 | 1uF | Cond. Poliestere scatolino |
| C42 | | |
| C43 | 100nF | Cond. Ceramico multistrato |
| C44 | 1nF | Cond. Ceramico multistrato |
| C45 | 100nF | Cond. Ceramico multistrato |
| C46 | 100nF | Cond. Ceramico multistrato |
| C47 | 1uF | Cond. Ceramico multistrato |
| C48 | 100nF | Cond. Ceramico multistrato |
| C49 | 100nF | Cond. Ceramico multistrato |
| C50 | 220nF | Cond. Ceramico multistrato |
| C51 | 100nF | Cond. Poliestere scatolino |
| C52 | 330pF | Cond. Ceramico multistrato |
| C53 | 4,7nF | Cond. Ceramico multistrato |
| CX | 1uF | Cond. Poliestere scatolino |
| D1 | 1N4148 | Diodo silicio |
| D2 | ZPD5,6V | Diodo zener |
| D3 | BAT48 | Diodo schottky |
| D4 | BYV27-200 | Fast recovery avalanche diode |
| D5 | 1N4148 | Diodo silicio |

Parts list

| Ref. | Description |
|-------|--|
| D6 | BYV27-200 Fast recovery avalance diode |
| D7 | 16CTQ100 Center-tape schottky diode |
| D8 | ZPD5,6V Diodo zener |
| D9 | BYV27-200 Diodo schottky |
| D10 | BYV27-200 Diodo schottky |
| D11 | BYV27-200 Diodo schottky |
| D12 | BYV27-200 Diodo schottky |
| D13 | DB3 Diodo diac |
| D14 | BZY97C24 Diodo zener |
| Q1 | BU406 Transistor NPN |
| Q2 | BC547B Transistor NPN |
| Q3 | BC547B Transistor NPN |
| Q4 | BC547B Transistor NPN |
| Q5 | BC337-25 Transistor NPN |
| Q6 | BC327-25 Transistor PNP |
| Q7 | BC327-25 Transistor PNP |
| MX | IRF3415 Powermos (47mOhm) |
| SC1 | MCR264 Thristor |
| IC1 | TL431-CLP Adjustable zener shunt regulator |
| IC2 | L4990 Current mode control PWM |
| IC3 | L6380 High-side driver |
| IC4 | LM358N Dual operation amplifier |
| IC5 | TL321C Operation amplifier |
| IC6 | LM317CT Adjustable regulator |
| IC7 | TL431-CLP Adjustable zener shunt regulator |
| Z1 | 220uH Induttanza HF a scatolino |
| Z2 | 220uH Induttanza HF a scatolino |
| Z3 | 100uH Induttanza HF a scatolino |
| Z4 | 2,2mH Induttanza HF a scatolino |
| Z5 | 2,2mH Induttanza HF a scatolino |
| CT | TRI120-1 Current trasformer |
| PI | IN27V-1 Power inductor |
| EM1 | EMI360-1 EMI Filter |
| EM2 | EMI360-1 EMI Filter |
| J1 | AMPMODU II Connettore Maschio 2pin dritto |
| J2 | AMPMODU II Connettore Maschio 2pin dritto |
| J3 | AMPMODU II Connettore Maschio 2pin dritto |
| J4 | AMPMODU II Connettore Maschio 2pin dritto |
| J5 | AMPMODU II Connettore Maschio 2pin dritto |
| FT1-9 | DB9 Conn. A vasch. Filtrato 9pin Maschio |
| FTA-D | Filtro feed-through a bullone |

Serigrafia monoscheda *Pag 5 file A3*

Pag 6 file A3
Schema VCO

Pag 7 file A3
schema PLL

Pag 8 file A3
Schema MPX

Pag 9 file A3
Schema AGC

Pag 10 file A3
Schema CPU

Parts list

| Ref. | Description |
|------|---|
| CN1 | HEADER 10 Connett. per flat cable 2X5 |
| CN2 | AMP MODU II Connett. AMP MODU 2pin p 2,54 |
| CX1 | 47uF Cond. elettrolitico Case D |
| C25 | 47uF Cond. elettrolitico Case D |
| C30 | 47uF Cond. elettrolitico Case D |
| C33 | 47uF Cond. elettrolitico Case D |
| CX10 | 22uF 25V (montato volante) |
| C1 | 1nF Cond. ceramico SMT 0805 |
| C10 | 1nF Cond. ceramico SMT 0805 |
| C11 | 1nF Cond. ceramico SMT 0805 |
| C14 | 1nF Cond. ceramico SMT 0805 |
| C18 | 1nF Cond. ceramico SMT 0805 |
| C21 | 1nF Cond. ceramico SMT 0805 |
| C22 | 1nF Cond. ceramico SMT 0805 |
| C41 | 1nF Cond. ceramico SMT 0805 |
| C139 | 1nF Cond. ceramico SMT 0805 |
| C147 | 1nF Cond. ceramico SMT 0805 |
| C149 | 1nF Cond. ceramico SMT 0805 |
| C2 | 47uF Cond. tantalio Case 3528 |
| C3 | 4.7nF Cond. ceramico SMT 0805 |
| C5 | 4.7nF Cond. ceramico SMT 0805 |
| C6 | 4.7nF Cond. ceramico SMT 0805 |
| C9 | 4.7nF Cond. ceramico SMT 0805 |
| C12 | 4.7nF Cond. ceramico SMT 0805 |
| C13 | 4.7nF Cond. ceramico SMT 0805 |
| C19 | 4.7nF Cond. ceramico SMT 0805 |
| C23 | 4.7nF Cond. ceramico SMT 0805 |
| C24 | 4.7nF Cond. ceramico SMT 0805 |
| C26 | 4.7nF Cond. ceramico SMT 0805 |
| C27 | 4.7nF Cond. ceramico SMT 0805 |
| C28 | 4.7nF Cond. ceramico SMT 0805 |
| C29 | 4.7nF Cond. ceramico SMT 0805 |
| C31 | 4.7nF Cond. ceramico SMT 0805 |
| C32 | 4.7nF Cond. ceramico SMT 0805 |
| C34 | 4.7nF Cond. ceramico SMT 0805 |
| C35 | 4.7nF Cond. ceramico SMT 0805 |
| C40 | 4.7nF Cond. ceramico SMT 0805 |
| C157 | 4.7nF Cond. ceramico SMT 0805 |
| C158 | 4.7nF Cond. ceramico SMT 0805 |
| C152 | 220nF Cond. ceramico SMT 0805 |
| C4 | 220nF Cond. ceramico SMT 0805 |
| C7 | 100nF Cond. ceramico SMT 0805 |
| C15 | 100nF Cond. ceramico SMT 0805 |
| C17 | 100nF Cond. ceramico SMT 0805 |
| C20 | 100nF Cond. ceramico SMT 0805 |
| C42 | 100nF Cond. ceramico SMT 0805 |
| C43 | 100nF Cond. ceramico SMT 0805 |
| C44 | 100nF Cond. ceramico SMT 0805 |
| C45 | 100nF Cond. ceramico SMT 0805 |
| C47 | 100nF Cond. ceramico SMT 0805 |
| C49 | 100nF Cond. ceramico SMT 0805 |
| C50 | 100nF Cond. ceramico SMT 0805 |
| C51 | 100nF Cond. ceramico SMT 0805 |
| C52 | 100nF Cond. ceramico SMT 0805 |
| C54 | 100nF Cond. ceramico SMT 0805 |

Parts list

| Ref. | Description |
|------|--|
| C56 | 100nF Cond. ceramico SMT 0805 |
| C59 | 100nF Cond. ceramico SMT 0805 |
| C60 | 100nF Cond. ceramico SMT 0805 |
| C61 | 100nF Cond. ceramico SMT 0805 |
| C62 | 100nF Cond. ceramico SMT 0805 |
| C64 | 100nF Cond. ceramico SMT 0805 |
| C68 | 100nF Cond. ceramico SMT 0805 |
| C69 | 100nF Cond. ceramico SMT 0805 |
| C73 | 100nF Cond. ceramico SMT 0805 |
| C74 | 100nF Cond. ceramico SMT 0805 |
| C75 | 100nF Cond. ceramico SMT 0805 |
| C76 | 100nF Cond. ceramico SMT 0805 |
| C77 | 100nF Cond. ceramico SMT 0805 |
| C78 | 100nF Cond. ceramico SMT 0805 |
| C79 | 100nF Cond. ceramico SMT 0805 |
| C80 | 100nF Cond. ceramico SMT 0805 |
| C83 | 100nF Cond. ceramico SMT 0805 |
| C84 | 100nF Cond. ceramico SMT 0805 |
| C85 | 100nF Cond. ceramico SMT 0805 |
| C91 | 100nF Cond. ceramico SMT 0805 |
| C92 | 100nF Cond. ceramico SMT 0805 |
| C95 | 100nF Cond. ceramico SMT 0805 |
| C96 | 100nF Cond. ceramico SMT 0805 |
| C97 | 100nF Cond. ceramico SMT 0805 |
| C98 | 100nF Cond. ceramico SMT 0805 |
| C99 | 100nF Cond. ceramico SMT 0805 |
| C104 | 100nF Cond. ceramico SMT 0805 |
| C105 | 100nF Cond. ceramico SMT 0805 |
| C106 | 100nF Cond. ceramico SMT 0805 |
| C108 | 100nF Cond. ceramico SMT 0805 |
| C109 | 100nF Cond. ceramico SMT 0805 |
| C113 | 100nF Cond. ceramico SMT 0805 |
| C116 | 100nF Cond. ceramico SMT 0805 |
| C121 | 100nF Cond. ceramico SMT 0805 |
| C122 | 100nF Cond. ceramico SMT 0805 |
| C124 | 100nF Cond. ceramico SMT 0805 |
| C125 | 100nF Cond. ceramico SMT 0805 |
| C127 | 100nF Cond. ceramico SMT 0805 |
| C128 | 100nF Cond. ceramico SMT 0805 |
| C135 | 100nF Cond. ceramico SMT 0805 |
| C138 | 100nF Cond. ceramico SMT 0805 |
| C140 | 100nF Cond. ceramico SMT 0805 |
| C151 | 100nF Cond. ceramico SMT 0805 |
| C153 | 100nF Cond. ceramico SMT 0805 |
| C155 | 100nF Cond. ceramico SMT 0805 |
| C185 | 100nF Cond. ceramico SMT 0805 |
| C8 | 1uF Cond. poliestere SMT (NON MONTARE) |
| C16 | 22nF Cond. ceramico SMT 0805 |
| C36 | 10uF Cond. elettrolitico SMT Case C |
| C38 | 10uF Cond. elettrolitico SMT Case C |
| C144 | 10uF Cond. elettrolitico SMT Case C |
| C150 | 10uF Cond. elettrolitico SMT Case C |
| C39 | 10uF Cond. elettrolitico Case C |
| C37 | 10uF Cond. elettrolitico Case C |
| C46 | 4n7 Cond. ceramico SMT 0805 |

Parts list

| Ref. | Description |
|------|---|
| C48 | 4n7 Cond. ceramico SMT 0805 |
| C58 | 4n7 Cond. ceramico SMT 0805 |
| C63 | 4n7 Cond. ceramico SMT 0805 |
| C67 | 4n7 Cond. ceramico SMT 0805 |
| C72 | 4n7 Cond. ceramico SMT 0805 |
| C53 | 22pF Cond. ceramico SMT 0805 |
| C57 | 22pF Cond. ceramico SMT 0805 |
| C55 | 10uF Cond elettrolitico SMT Case C |
| C86 | 10uF Cond elettrolitico SMT Case C |
| C87 | 10uF Cond elettrolitico SMT Case C |
| C88 | 10uF Cond elettrolitico SMT Case C |
| C89 | 10uF Cond elettrolitico SMT Case C |
| C65 | 68pF Cond. ceramico SMT 0805 |
| C66 | 68pF Cond. ceramico SMT 0805 |
| C70 | 68pF Cond. ceramico SMT 0805 |
| C71 | 68pF Cond. ceramico SMT 0805 |
| C81 | 470nF Cond elettrolitico SMT Case B |
| C82 | 10uF/25V Cond elettrolitico SMT Case C |
| C90 | 10uF/25V Cond elettrolitico SMT Case C |
| C93 | 4.7uF Cond. elettrolitico SMT Case B |
| C94 | 100pF Cond. ceramico SMT 0805 |
| C100 | 100pF Cond. ceramico SMT 0805 |
| C107 | 100pF Cond. ceramico SMT 0805 |
| C101 | 10pF Cond. ceramico SMT 0805 |
| C102 | 10pF Cond. ceramico SMT 0805 |
| C114 | 10pF Cond. ceramico SMT 0805 |
| C112 | 2.2nF Cond. poliestere SMT |
| C103 | 2.2nF Cond. poliestere SMT |
| C110 | 10nF Cond. poliestere SMT |
| C111 | 47uF Cond. tantalio SMT Case 3528 |
| C115 | 220nF Cond. poliestere SMT |
| C119 | 4,7uF Cond. tantalio SMT Case 3528 |
| C126 | 4,7uF Cond. tantalio SMT Case 3528 |
| C120 | 10uF Cond. tantalio SMT Case 3528 |
| C123 | 10uF NP Cond. elettrolitico SMT Case C |
| C129 | 100uF Cond. tantalio SMT Case 7343 |
| C130 | 100uF Cond. tantalio SMT Case 7343 |
| C132 | 100uF Cond. tantalio SMT Case 7343 |
| C133 | 100uF Cond. tantalio SMT Case 7343 |
| C134 | 100uF Cond. tantalio SMT Case 7343 |
| C131 | 47uF Cond. tantalio SMT Case 7343 |
| C136 | 22uF Cond. elettrolitico SMT Case C |
| C137 | 10nF Cond. ceramico SMT 0805 |
| C141 | 1500uF Cond elettolitico Vert. 6,3V |
| C142 | 68uF Cond. tantalio SMT Case 7343 |
| C143 | 47nF Cond. ceramico SMT 0805 (NON MONTARE) |
| C145 | 220pF Cond. ceramico SMT 0805 |
| C146 | 100nF Cond. ceramico SMT 0805 (NON MONTARE) |
| C148 | 470uF Cond. elettrolitico passo 5,08 |
| C154 | 27pF Cond. ceramico SMT 0805 |
| C156 | 47uF Cond. elettrolitico SMT Case D |
| C159 | 4.7pF Cond. ceramico SMT 0805 |
| C160 | 33uF Cond. elettrolitico SMT Case C |
| C161 | 4.7nF Cond. ceramico SMT ATC 0805 X7R472KL2AT |
| C162 | 4.7nF Cond. ceramico SMT ATC 0805 X7R472KL2AT |

Parts list

| Ref. | Description | |
|------|-------------|--|
| C163 | 4.7nF | Cond. ceramico SMT ATC 0805 X7R472KL2AT |
| C164 | 4.7nF | Cond. ceramico SMT ATC 0805 X7R472KL2AT |
| C165 | 4.7nF | Cond. ceramico SMT ATC 0805 X7R472KL2AT |
| C167 | 4.7nF | Cond. ceramico SMT ATC 0805 X7R472KL2AT |
| C168 | 4.7nF | Cond. ceramico SMT ATC 0805 X7R472KL2AT |
| C173 | 4.7nF | Cond. ceramico SMT ATC 0805 X7R472KL2AT |
| C175 | 4.7nF | Cond. ceramico SMT ATC 0805 X7R472KL2AT |
| C176 | 4.7nF | Cond. ceramico SMT ATC 0805 X7R472KL2AT |
| C183 | 4.7nF | Cond. ceramico SMT ATC 0805 X7R472KL2AT |
| C184 | 4.7nF | Cond. ceramico SMT ATC 0805 X7R472KL2AT |
| C166 | 4.7uF | Cond. tantalio SMT Case 3528 16V |
| C169 | 1uF | Cond. tantalio SMT Case 3528 16V (non montare) |
| C182 | 33uF | Cond. elettrolitico SMT Case D 25V |
| C170 | 33uF | Cond. elettrolitico SMT Case D 25V |
| C171 | 1nF | Cond. ceramico tipo tradizionale |
| C172 | 1nF | Cond. ceramico SMT ATC 0805 X7R472KL2AT |
| C174 | 1nF | Cond. ceramico SMT ATC 0805 X7R472KL2AT |
| C180 | 1nF | Cond. ceramico SMT ATC 0805 X7R472KL2AT |
| C181 | 1nF | Cond. ceramico SMT ATC 0805 X7R472KL2AT |
| C177 | 470pF | Cond. ceramico SMT ATC 0805 X7R472KL2AT |
| C178 | 15pF | Cond. ceramico SMT ATC 0805 X7R472KL2AT |
| C179 | 220pF | Cond. ceramico SMT ATC 0805 X7R472KL2AT |
| DL1 | LED | Led 3mm |
| DX10 | 1N82A | Diodo SMT MiniMelf (montato volante) |
| D5 | 4.7V | Diodo SMT MiniMelf |
| DZ1 | 4.7V | Diodo SMT MiniMelf |
| DZ20 | 10V 1/4W | Diodo Zener (montato volante) |
| D1 | LM336-2.5V | Riferim. di tensione SMT SOIC8 |
| D2 | 1N4148 | Diodo SMT MiniMelf |
| D3 | 1N4148 | Diodo SMT MiniMelf |
| D4 | 1N4148 | Diodo SMT MiniMelf |
| D6 | 1N4148 | Diodo SMT MiniMelf |
| D7 | 1N4148 | Diodo SMT MiniMelf |
| D8 | 1N4148 | Diodo SMT MiniMelf |
| D9 | LM336/SO | Riferim. di tensione SMT SOIC8 |
| D10 | 1N4148 | Diodo SMT Case MiniMelf |
| D11 | 1N4148 | Diodo SMT Case MiniMelf |
| D12 | 1N4148 | Diodo SMT Case MiniMelf |
| D13 | 1N4148 | Diodo SMT Case MiniMelf |
| D14 | 1N4148 | Diodo SMT Case MiniMelf |
| D15 | 1N4148 | Diodo SMT Case MiniMelf |
| D16 | 1N4148 | Diodo SMT Case MiniMelf |
| D17 | 1N4148 | Diodo SMT Case MiniMelf |
| D23 | 1N4148 | Diodo SMT Case MiniMelf |
| D24 | 1N4148 | Diodo SMT Case MiniMelf |
| D25 | 1N4148 | Diodo SMT Case MiniMelf |
| D26 | 1N4148 | Diodo SMT Case MiniMelf |
| D27 | 1N4148 | Diodo SMT Case MiniMelf |
| D29 | 1N4148 | Diodo SMT Case MiniMelf |
| D18 | 1N4002 | Diodo SMT Case Melf |
| D19 | 1N4002 | Diodo SMT Case Melf |
| D20 | 1N4148 | Diodo SMT Case MiniMelf (montato volante) |
| D22 | 1N4148 | Diodo SMT Case MiniMelf (NON MONTARE) |
| D21 | 1N4148 | Diodo SMT Case MiniMelf (NON MONTARE) |
| D30 | BAT42 | Diodo Schottky assiale passo 10mm |

Parts list

| Ref. | Description |
|------|--|
| D28 | BAT42 Diodo Schottky assiale passo 10mm |
| D31 | 3V Diodo Zener MiniMelf (NON MONTARE) |
| D32 | US1A o 1N4148 Diodo SMD Case DO214 |
| D33 | BB515 Diodo Varicap SMT SOD323 |
| D34 | BB515 Diodo Varicap SMT SOD323 |
| D35 | BB515 Diodo Varicap SMT SOD323 |
| D36 | BB515 Diodo Varicap SMT SOD323 |
| D37 | BB515 Diodo Varicap SMT SOD323 |
| D38 | BB515 Diodo Varicap SMT SOD323 |
| D39 | BB515 Diodo Varicap SMT SOD323 |
| D40 | BB515 Diodo Varicap SMT SOD323 |
| D41 | BB515 Diodo Varicap SMT SOD323 |
| D42 | BB515 Diodo Varicap SMT SOD323 |
| D43 | BB515 Diodo Varicap SMT SOD323 |
| D44 | BB515 Diodo Varicap SMT SOD323 |
| ISO1 | NEC 2501 Fotoaccoppiatore NEC Dip8 |
| JB1 | CON26 Connettore DIN 41651 femm. vert. 2X13 pin |
| JB2 | CON16 Connett. DIN 41651 femm. vert. 2X10 pin |
| JD1 | CON26 Connettore per flat cable 2X13 pin (con ganci) |
| JP1 | Jumper 3 poli Jumper 3 pin con ponticello |
| JP4 | Jumper 3 poli Jumper 3 pin con ponticello |
| JP3 | JUMPER Jumper |
| JP2 | JUMPER Jumper |
| J1 | CON8 Connettore passo 3,96mm |
| J2 | DSUB9R Connett. a vaschetta 9 poli femm. 90° |
| J3 | BNC BNC da pannello isolato |
| J4 | BNC BNC da pannello isolato |
| J5 | BNC BNC da pannello isolato |
| J6 | SMB CS M VERT Connett. SMB vert. |
| J8 | SMB CS M VERT Connett. SMB vert. |
| J9 | DSUB25R Connett. a vaschetta 25 poli femm. 90° |
| L1 | 2.2uH Induttanza SMT 1212 |
| L2 | 2.2uH Induttanza SMT 1212 |
| L3 | 2.2uH Induttanza SMT 1212 |
| L4 | 2.2uH Induttanza SMT 1212 |
| L5 | 2.2uH Induttanza passo 10mm |
| L6 | 2.2uH Induttanza passo 10mm |
| L7 | 2.2uH Induttanza passo 10mm |
| L9 | 10uH-1A Induttanza assiale passo 10mm |
| L8 | 10uH-1A Induttanza assiale passo 10mm |
| L10 | 1mH Induttanza assiale passo 10mm |
| L11 | 1mH Induttanza assiale passo 10mm |
| L12 | 1mH Induttanza assiale passo 10mm |
| L13 | 2.2uH Induttanza assiale passo 10mm |
| L14 | 2.2uH Induttanza assiale passo 10mm |
| L15 | 2.2uH Induttanza assiale passo 10mm |
| L16 | 2.2uH Induttanza assiale passo 10mm |
| L22 | 2.2uH Induttanza assiale passo 10mm |
| L18 | 2.2uH Induttanza assiale passo 7,5mm |
| L17 | 2.2uH Induttanza assiale passo 7,5mm |
| L19 | 2.2uH Induttanza assiale passo 7,5mm |
| L20 | 2.2uH Induttanza assiale passo 7,5mm |
| L21 | 2.2uH Induttanza assiale passo 7,5mm |
| QX1 | BC817 Transistor SMT SOT23 |
| Q1 | BC817 Transistor SMT SOT23 |

Parts list

| Ref. | Description | |
|------|-------------|---------------------------------------|
| Q3 | BC817 | Transistor SMT SOT23 |
| Q4 | BC817 | Transistor SMT SOT23 |
| Q6 | BC817 | Transistor SMT SOT23 |
| Q2 | FMMT619 | Transistor SMT SOT23 |
| Q7 | SMBT2222A | Transistor SMT SOT23 |
| Q5 | SMBT2222A | Transistor SMT SOT23 |
| Q8 | BC850 | Transistor SMT SOT23 |
| Q9 | BF998 | Fet SMT SOT143 |
| Q10 | BF998 | Fet SMT SOT143 |
| RR2 | 10K | Rete resistiva 9+1 |
| RR1 | 10K | Rete resistiva 9+1 |
| RR3 | 47K | Rete resistiva 8 R singole SMT SOIC16 |
| RR4 | 47K | Rete resistiva 8 R singole SMT SOIC16 |
| RW1 | 0 ohm | Ponticello di corto circuito |
| RX1 | 4K7 | Resistenza SMT 0805 5% |
| RX2 | 4K7 | Resistenza SMT 0805 5% |
| RX3 | 4K7 | Resistenza SMT 0805 5% |
| RX7 | 4K7 | Resistenza SMT 0805 5% |
| R18 | 4K7 | Resistenza SMT 0805 5% |
| R27 | 4K7 | Resistenza SMT 0805 5% |
| R136 | 4K7 | Resistenza SMT 0805 5% |
| R140 | 4K7 | Resistenza SMT 0805 5% |
| R150 | 4K7 | Resistenza SMT 0805 5% |
| R161 | 4K7 | Resistenza SMT 0805 5% |
| R2 | 10K | Resistenza SMT 0805 5% |
| RX4 | 10K | Resistenza SMT 0805 5% |
| R4 | 10K | Resistenza SMT 0805 5% |
| RX5 | 10K | Resistenza SMT 0805 5% |
| RX8 | 10K | Resistenza SMT 0805 5% |
| R13 | 10K | Resistenza SMT 0805 5% |
| R15 | 10K | Resistenza SMT 0805 5% |
| R20 | 10K | Resistenza SMT 0805 5% |
| R21 | 10K | Resistenza SMT 0805 5% |
| R24 | 10K | Resistenza SMT 0805 5% |
| R25 | 10K | Resistenza SMT 0805 5% |
| R28 | 10K | Resistenza SMT 0805 5% |
| R37 | 10K | Resistenza SMT 0805 5% |
| R39 | 10K | Resistenza SMT 0805 5% |
| R40 | 10K | Resistenza SMT 0805 5% |
| R43 | 10K | Resistenza SMT 0805 5% |
| R44 | 10K | Resistenza SMT 0805 5% |
| R46 | 10K | Resistenza SMT 0805 5% |
| R47 | 10K | Resistenza SMT 0805 5% |
| R49 | 10K | Resistenza SMT 0805 5% |
| R50 | 10K | Resistenza SMT 0805 5% |
| R51 | 10K | Resistenza SMT 0805 5% |
| R52 | 10K | Resistenza SMT 0805 5% |
| R53 | 10K | Resistenza SMT 0805 5% |
| R54 | 10K | Resistenza SMT 0805 5% |
| R56 | 10K | Resistenza SMT 0805 5% |
| R57 | 10K | Resistenza SMT 0805 5% |
| R59 | 10K | Resistenza SMT 0805 5% |
| R61 | 10K | Resistenza SMT 0805 5% |
| R63 | 10K | Resistenza SMT 0805 5% |
| R67 | 10K | Resistenza SMT 0805 5% |

Parts list

| Ref. | Description | |
|------|-------------|--------------------------------------|
| R68 | 10K | Resistenza SMT 0805 5% |
| R72 | 10K | Resistenza SMT 0805 5% |
| R84 | 10K | Resistenza SMT 0805 5% |
| R104 | 10K | Resistenza SMT 0805 5% |
| R105 | 10K | Resistenza SMT 0805 5% |
| R108 | 10K | Resistenza SMT 0805 5% |
| R110 | 10K | Resistenza SMT 0805 5% |
| R131 | 10K | Resistenza SMT 0805 5% |
| R137 | 10K | Resistenza SMT 0805 5% |
| R146 | 10K | Resistenza SMT 0805 5% |
| R162 | 10K | Resistenza SMT 0805 5% |
| R174 | 10K | Resistenza SMT 0805 5% |
| RX6 | 0 | Resistenza SMT 0805 5% |
| RX10 | 10 | Resistenza 5% (montato volante) |
| RX20 | 0 ohm | Ponticello di rame (montato volante) |
| R1 | 470 | Resistenza SMT 0805 5% |
| R9 | 470 | Resistenza SMT 0805 5% |
| R35 | 470 | Resistenza SMT 0805 5% |
| R55 | 470 | Resistenza SMT 0805 5% |
| R58 | 470 | Resistenza SMT 0805 5% |
| R64 | 470 | Resistenza SMT 0805 5% |
| R133 | 470 | Resistenza SMT 0805 5% |
| R143 | 470 | Resistenza SMT 0805 5% |
| R148 | 470 | Resistenza SMT 0805 5% |
| R155 | 470 | Resistenza SMT 0805 5% |
| R156 | 470 | Resistenza SMT 0805 5% |
| R157 | 470 | Resistenza SMT 0805 5% |
| R172 | 470 | Resistenza SMT 0805 5% |
| R182 | 470 | Resistenza SMT 0805 5% |
| R183 | 470 | Resistenza SMT 0805 5% |
| R3 | 22 | Resistenza SMT 0805 5% |
| R10 | 22 | Resistenza SMT 0805 5% |
| R14 | 22 | Resistenza SMT 0805 5% |
| R22 | 22 | Resistenza SMT 0805 5% |
| R29 | 22 | Resistenza SMT 0805 5% |
| R32 | 22 | Resistenza SMT 0805 5% |
| R41 | 22 | Resistenza SMT 0805 5% |
| R109 | 22 | Resistenza SMT 0805 5% |
| R5 | 470K | Resistenza SMT 0805 5% |
| R17 | 470K | Resistenza SMT 0805 5% |
| R152 | 5K6 | Resistenza SMT 0805 5% |
| R6 | 5K6 | Resistenza SMT 0805 5% |
| R7 | 10 | Resistenza SMT 0805 5% |
| R12 | 10 | Resistenza SMT 0805 5% |
| R121 | 10 | Resistenza SMT 0805 5% |
| R129 | 10 | Resistenza SMT 0805 5% |
| R177 | 10 | Resistenza SMT 0805 5% |
| R8 | 220K | Resistenza SMT 0805 5% |
| R11 | 220K | Resistenza SMT 0805 5% |
| R23 | 220K | Resistenza SMT 0805 5% |
| R16 | 8K2 | Resistenza SMT 0805 5% |
| R19 | 1M | Resistenza SMT 0805 5% |
| R36 | 1M | Resistenza SMT 0805 5% |
| R124 | 1M | Resistenza SMT 0805 5% |
| R141 | 1M | Resistenza SMT 0805 5% |

Parts list

| Ref. | Description |
|------|--------------------------------|
| R26 | 1K Resistenza SMT 0805 5% |
| R30 | 1K Resistenza SMT 0805 5% |
| R33 | 1K Resistenza SMT 0805 5% |
| R34 | 1K Resistenza SMT 0805 5% |
| R42 | 1K Resistenza SMT 0805 5% |
| R60 | 1K Resistenza SMT 0805 5% |
| R70 | 1K Resistenza SMT 0805 5% |
| R76 | 1K Resistenza SMT 0805 5% |
| R147 | 1K Resistenza SMT 0805 5% |
| R158 | 1K Resistenza SMT 0805 5% |
| R160 | 1K Resistenza SMT 0805 5% |
| R31 | 2K2 Resistenza SMT 0805 5% |
| R38 | 2K2 Resistenza SMT 0805 5% |
| R86 | 2K2 Resistenza SMT 0805 5% |
| R100 | 2K2 Resistenza SMT 0805 5% |
| R164 | 2K2 Resistenza SMT 0805 5% |
| R48 | 18K Resistenza SMT 0805 5% |
| R45 | 18K Resistenza SMT 0805 5% |
| R62 | 100 Resistenza SMT 0805 5% |
| R138 | 100 Resistenza SMT 0805 5% |
| R163 | 100 Resistenza SMT 0805 5% |
| R66 | 100K Resistenza SMT 0805 5% |
| R65 | 100K Resistenza SMT 0805 5% |
| R69 | 4K99 1% Resistenza SMT 0805 1% |
| R71 | 4K99 1% Resistenza SMT 0805 1% |
| R74 | 4K99 1% Resistenza SMT 0805 1% |
| R75 | 4K99 1% Resistenza SMT 0805 1% |
| R79 | 4K99 1% Resistenza SMT 0805 1% |
| R81 | 4K99 1% Resistenza SMT 0805 1% |
| R83 | 4K99 1% Resistenza SMT 0805 1% |
| R89 | 4K99 1% Resistenza SMT 0805 1% |
| R91 | 4K99 1% Resistenza SMT 0805 1% |
| R92 | 4K99 1% Resistenza SMT 0805 1% |
| R93 | 4K99 1% Resistenza SMT 0805 1% |
| R96 | 4K99 1% Resistenza SMT 0805 1% |
| R102 | 4K99 1% Resistenza SMT 0805 1% |
| R106 | 4K99 1% Resistenza SMT 0805 1% |
| R107 | 4K99 1% Resistenza SMT 0805 1% |
| R117 | 4K99 1% Resistenza SMT 0805 1% |
| R118 | 4K99 1% Resistenza SMT 0805 1% |
| R120 | 4K99 1% Resistenza SMT 0805 1% |
| R122 | 4K99 1% Resistenza SMT 0805 1% |
| R123 | 4K99 1% Resistenza SMT 0805 1% |
| R127 | 4K99 1% Resistenza SMT 0805 1% |
| R73 | 100 1% Resistenza SMT 0805 1% |
| R77 | 100 1% Resistenza SMT 0805 1% |
| R103 | 100 1% Resistenza SMT 0805 1% |
| R115 | 100 1% Resistenza SMT 0805 1% |
| R119 | 100 1% Resistenza SMT 0805 1% |
| R126 | 100 1% Resistenza SMT 0805 1% |
| R78 | 1K 1% Resistenza SMT 0805 1% |
| R80 | 1K 1% Resistenza SMT 0805 1% |
| R82 | 1K 1% Resistenza SMT 0805 1% |
| R95 | 1K 1% Resistenza SMT 0805 1% |
| R98 | 1K 1% Resistenza SMT 0805 1% |

Parts list

| Ref. | Description | |
|------|-------------|-----------------------------|
| R99 | 1K 1% | Resistenza SMT 0805 1% |
| R112 | 1K 1% | Resistenza SMT 0805 1% |
| R85 | 47K | Resistenza SMT 0805 5% |
| R113 | 47K | Resistenza SMT 0805 5% |
| R149 | 47K | Resistenza SMT 0805 5% |
| R101 | 220 | Resistenza SMT 0805 5% |
| R87 | 220 | Resistenza SMT 0805 5% |
| R88 | 4K42 1% | Resistenza SMT 0805 1% |
| R90 | 47 | Resistenza SMT 0805 5% |
| R97 | 47 | Resistenza SMT 0805 5% |
| R128 | 47 | Resistenza SMT 0805 5% |
| R94 | 100R | Resistenza SMT 0805 5% |
| R111 | 100R | Resistenza SMT 0805 5% |
| R116 | 100R | Resistenza SMT 0805 5% |
| R114 | 6M8 | Resistenza SMT 0805 5% |
| R125 | 22K | Resistenza SMT 0805 5% |
| R130 | 2K7 | Resistenza SMT 0805 5% |
| R135 | 2K7 | Resistenza SMT 0805 5% |
| R151 | 2K7 | Resistenza SMT 0805 5% |
| R180 | 120 | Resistenza SMT 0805 5% |
| R132 | 120 | Resistenza SMT 0805 5% |
| R134 | 27 | Resistenza SMT 0805 5% |
| R139 | 56 | Resistenza SMT 0805 5% |
| R170 | 56 | Resistenza SMT 0805 5% |
| R176 | 56 | Resistenza SMT 0805 5% |
| R179 | 56 | Resistenza SMT 0805 5% |
| R184 | 56 | Resistenza SMT 0805 5% |
| R142 | 27K | Resistenza SMT 0805 5% |
| R165 | 27K | Resistenza SMT 0805 5% |
| R144 | 390 | Resistenza SMT 0805 5% |
| R145 | 1K5 | Resistenza SMT 0805 5% |
| R153 | 6K | Resistenza SMT 0805 5% |
| R154 | 12K | Resistenza SMT 0805 5% |
| R166 | 12K | Resistenza SMT 0805 5% |
| R167 | 12K | Resistenza SMT 0805 5% |
| R159 | 15K | Resistenza SMT 0805 5% |
| R178 | 270 | Resistenza assiale 1/4W 10% |
| R168 | 270 | Resistenza assiale 1/4W 10% |
| R169 | 620 | Resistenza SMT 0805 5% |
| R171 | 820 | Resistenza SMT 0805 5% |
| R173 | 330K | Resistenza SMT 0805 5% |
| R175 | 15 | Resistenza SMT 0805 5% |
| R181 | 20K | Resistenza SMT 0805 5% |
| SC1 | SCREW | Vite fissaggio N3X5mm |
| SC2 | SCREW | Vite fissaggio N3X5mm |
| SC3 | SCREW | Vite fissaggio N3X5mm |
| SC4 | SCREW | Vite fissaggio N3X5mm |
| SC5 | SCREW | Vite fissaggio N3X5mm |
| SC6 | SCREW | Vite fissaggio N3X5mm |
| SC7 | SCREW | Vite fissaggio N3X5mm |
| SH1 | VCO SHELD | Scatolino VCO e PLL |
| SH2 | PLL SHELD | Scatolino VCO e PLL |
| TL1 | 75 ohm | Cavo coassiale Belden |
| TP1 | INP | Test point |
| TP2 | OUT | Test point |

Parts list

| Ref. | Description |
|------|---|
| TP3 | SCA Test point |
| TP4 | LEV CC Test point |
| TP5 | VpII TEST POINT Test point |
| U2 | LM324 IC SMT SOIC14 |
| U1 | LM324 IC SMT SOIC14 |
| U3 | LMC7101/SOT23 Op-Amp SMT SOT23-5 |
| U8 | LMC7101/SOT23 Op-Amp SMT SOT23-5 |
| U14 | LMC7101/SOT23 Op-Amp SMT SOT23-5 |
| U21 | LMC7101/SOT23 Op-Amp SMT SOT23-5 |
| U4 | PCF80C552 IC PLCC28 Con zoccolo |
| U5 | 74HC138 IC SMT SOIC16 |
| U6 | 74HC00 IC SMT SOIC14 |
| U10 | 74HC574 IC SMT SOIC20 Wide |
| U7 | 74HC574 IC SMT SOIC20 Wide |
| U9 | 7421 IC SMT SOIC14 |
| U11 | TL7705 IC SMT SOIC8 |
| U12 | 74HC08 |
| U13 | 74HC157AS IC SMT SOIC16 |
| U15 | 74HC573 IC SMT SOIC20 Wide |
| U16 | 74HC245 IC SMT SOIC20 Wide |
| U20 | 74HC245 IC SMT SOIC20 Wide |
| U19 | MAX485 IC SMT SOIC8 |
| U17 | MAX485 IC SMT SOIC8 |
| U18 | AT27C020/LCC IC PLCC32 Con zoccolo |
| U22 | 62256 IC SMT SOIC28 Wide |
| U23 | ST24C02 IC SMT SOIC8 |
| U24 | MC74HC595 IC SMT SOIC16 |
| U25 | CS3310 IC SMT SOIC16 |
| U27 | MC33078 IC SMT SOIC8 |
| U26 | MC33078 IC SMT SOIC8 |
| U28 | SSM2404 IC SMT SOIC20 Wide |
| U29 | LF347 IC SMT SOIC14 |
| U31 | LF347 IC SMT SOIC14 |
| U30 | LF353 |
| U32 | LM79L05AC IC SMT SOIC8 |
| U34 | LF353 IC SMT SOIC8 |
| U35 | LM358 IC SMT SOIC8 |
| U39 | LM358 IC SMT SOIC8 |
| U36 | 10MHz TCXO SMT MEC |
| U37 | H11F1 Fotoaccoppiatore Dip6 |
| U38 | LMX1501AM IC SMT SOIC16 |
| U40 | AD797 o NE5534 IC SMT SOIC8 |
| U41 | AD587 IC SMT SOIC8 (non montare) |
| U42 | ERA 3 MMIC |
| U43 | ERA 3 MMIC |
| U44 | 74HC4067 IC SMT SOIC24 Wide |
| VR1 | 100K Trimmer multigiri vert. oin in linea |
| VR2 | 1K Trimmer multig. vert. pin in linea |
| VR4 | 10K Trimmer multig. lungo orizz. |
| VR3 | 10K Trimmer multig. lungo orizz. |
| VR5 | 50K Trimmer multig. vert. pin in linea |
| VR6 | 10K Trimmer multig. vert pin in linea |
| Y1 | 16MHz Quarzo HC49 |

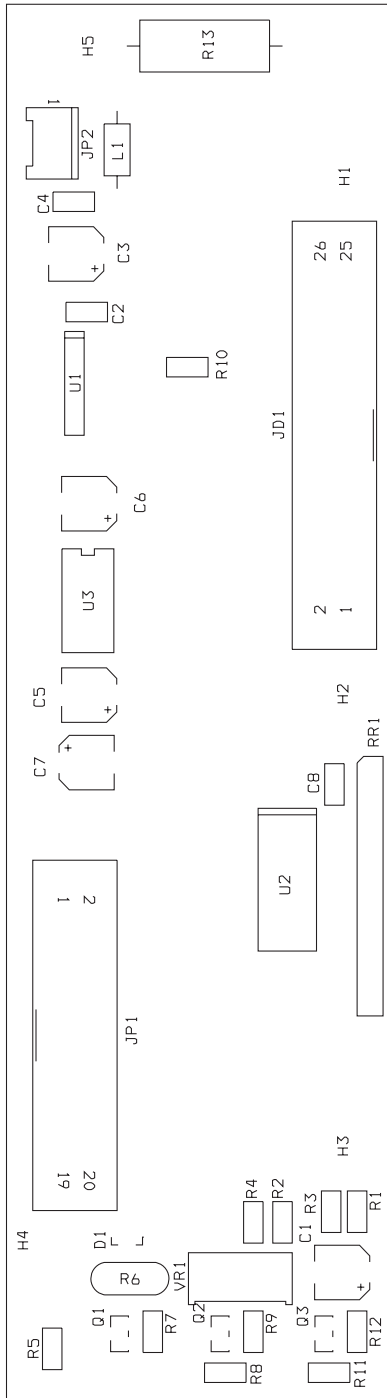



| | | |
|---|---------------------------------|------------------------|
|  Via G.Amendola 9 44028 Poggio Renatico (FE) Italy Tel +39 0532 829965 Fax +39 0532 829177 Website WWW.ELENOS.COM | | |
| | | Title: KEYBOARD |
| Board Code: KEYB.ETG500V1.0A | Model: ETG250/300 | Rev 1 |
| Proj. Engr. : A.Tomassini | Approved : A.Giovannelli | |
| Date: Wednesday, November 15, 2000 | Sheet | 1 of 1 |

Pag 11 file A3
Schema Keyboard

Parts list

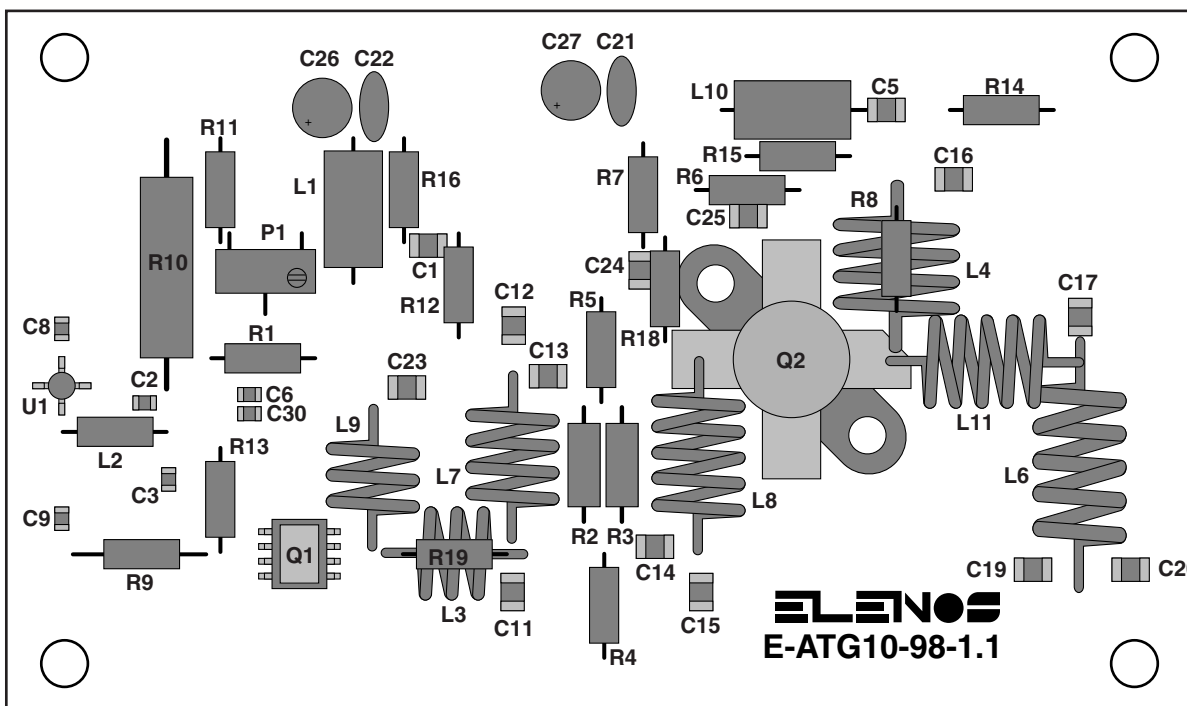
| Ref. | Description |
|------|-------------|
| C3 | 10uF/25V |
| C1 | 10uF/25V |
| C2 | 100nF |
| C4 | 100nF |
| C8 | 100nF |
| C5 | 10u |
| C6 | 10u |
| C7 | 10u |
| D1 | BAT64 |
| H1 | CON1 |
| H2 | CON1 |
| H3 | CON1 |
| H4 | CON1 |
| H5 | CON1 |
| JD1 | CON26 |
| JP1 | DISPLAY |
| JP2 | CONN 2 |
| LD1 | LED |
| LD2 | LED |
| LD3 | LED |
| L1 | 2,2uH |
| SW1 | SWITCH |
| P1 | SWITCH |
| P2 | SWITCH |
| P3 | SWITCH |
| P4 | SWITCH |
| P5 | SWITCH |
| P6 | SWITCH |
| P7 | SWITCH |
| P8 | SWITCH |
| Q1 | BC817 |
| Q2 | BC817 |
| Q3 | BC817 |
| RR1 | 10K |
| R7 | 10K |
| R9 | 10K |
| R10 | 10K |
| R12 | 10K |
| R1 | 4K7 |
| R2 | N.M. |
| R3 | 2K2 |
| R4 | 1K |
| VR1 | 1K |
| R5 | 330 |
| R8 | 330 |
| R11 | 330 |
| R6 | VARISTOR |
| R13 | 3,3 2W |
| U1 | 14042 |
| U2 | 74HC245 |
| U3 | LTC1054CN8 |



| | | | |
|--|------------------------------|---|---------------|
|  | | Via G.Amendola 9 44028 Poggio Renatico (FE) Italy | |
| | | Tel +39 0532 829965 Fax +39 0532 829177 | |
| | | Website WWW.ELENOS.COM | |
| Title: DRIVER | | | |
| Board Code: | E-ATG-98-1.1 | Model: | ETG250/300 |
| Proj. Engr. : | A.Tomassini | Approved : | A.Giovannelli |
| Date: | Wednesday, November 15, 2000 | Sheet | 1 of 1 |

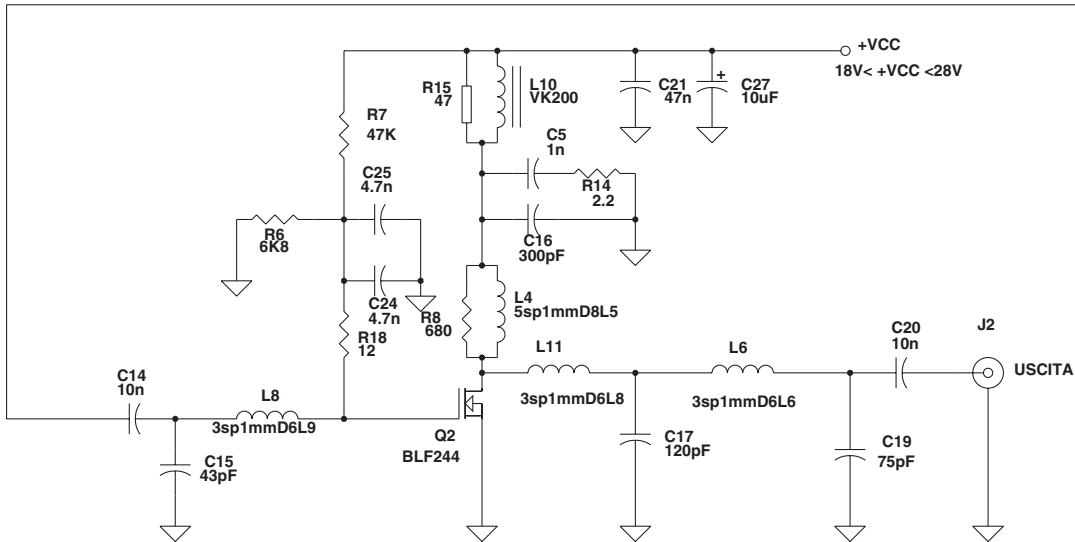
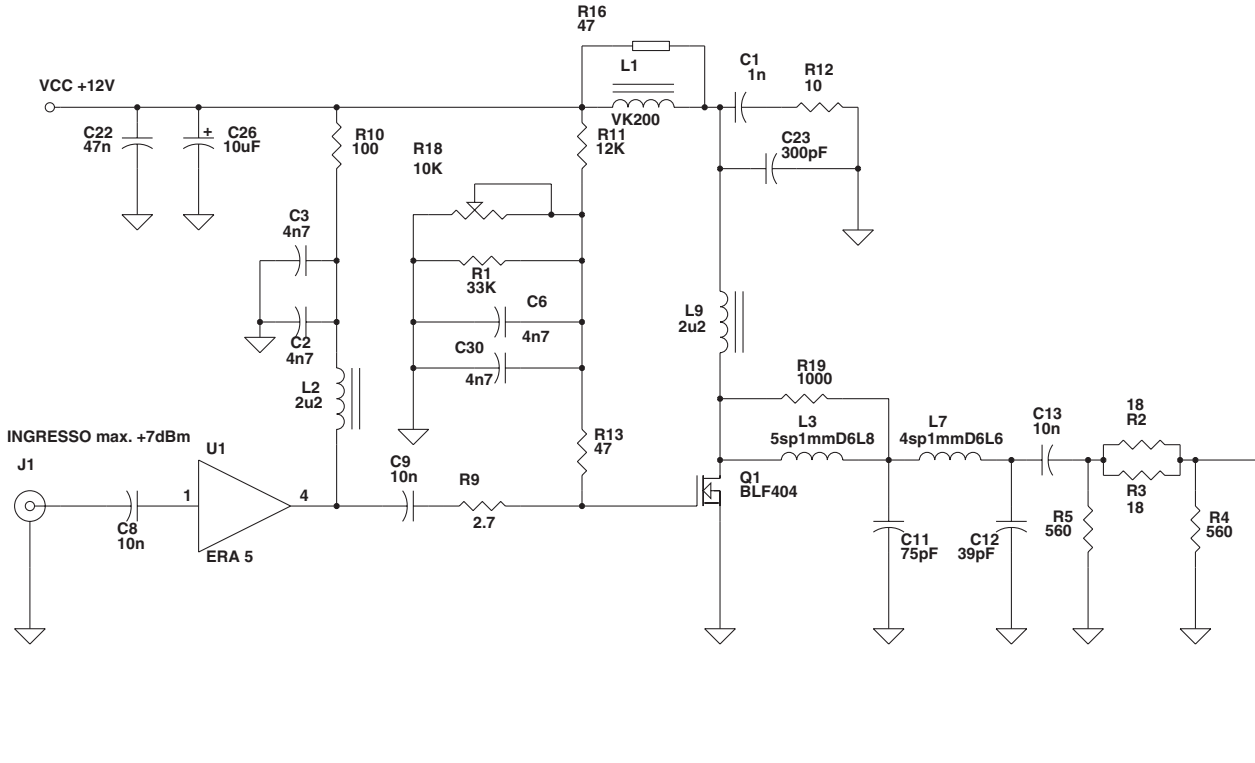

| | | | |
|---------------|------------------------------|---|---------------|
| | | Via G.Amendola 9 44028 Poggio Renatico (FE) Italy | |
| | | Tel +39 0532 829965 Fax +39 0532 829177 | |
| | | Website WWW.ELENOS.COM | |
| Title: DRIVER | | | |
| Board Code: | E-ATG10-98-1.1 | Model: | ETG250/300 |
| Proj. Engr. : | A.Tomassini | Approved : | A.Giovannelli |
| Date: | Wednesday, November 15, 2000 | Sheet | 1 of 1 |

Parts list

| Ref. | Description |
|------|---------------------|
| C1 | 1n |
| C5 | 1n |
| C2 | 4n7 |
| C3 | 4n7 |
| C6 | 4n7 |
| C30 | 4n7 |
| C8 | 10n |
| C9 | 10n |
| C13 | 10n |
| C14 | 10n |
| C20 | 10n |
| C19 | 75pF |
| C11 | 75pF |
| C12 | 39pF |
| C15 | 43pF |
| C16 | 300pF |
| C23 | 300pF |
| C17 | 120pF |
| C22 | 47n |
| C21 | 47n |
| C24 | 4.7n |
| C25 | 4.7n |
| C27 | 10uF |
| C26 | 10uF |
| J1 | INGRESSO max. +7dBm |
| J2 | USCITA |
| L1 | VK200 |
| L10 | VK200 |
| L2 | 2u2 |
| L9 | 2u2 |
| L3 | 5sp1mmD6L8 |
| L4 | 5sp1mmD8L5 |
| L6 | 3sp1mmD6L6 |
| L7 | 4sp1mmD6L6 |
| L8 | 3sp1mmD6L9 |
| L11 | 3sp1mmD6L8 |
| Q1 | BLF404 |
| Q2 | BLF244 |
| R1 | 33K |
| R2 | 18 |
| R3 | 18 |
| R4 | 560 |
| R5 | 560 |
| R6 | 6K8 |
| R7 | 47K |
| R8 | 680 |
| R9 | 2.7 |
| R10 | 100 |
| R11 | 12K |
| R12 | 10 |
| R13 | 47 |
| R15 | 47 |
| R16 | 47 |
| R14 | 2.2 |
| R18 | 10K |

Parts list

| Ref. | Description |
|------|-------------|
| R18 | 12 |
| R19 | 1000 |
| U1 | ERA 5 |

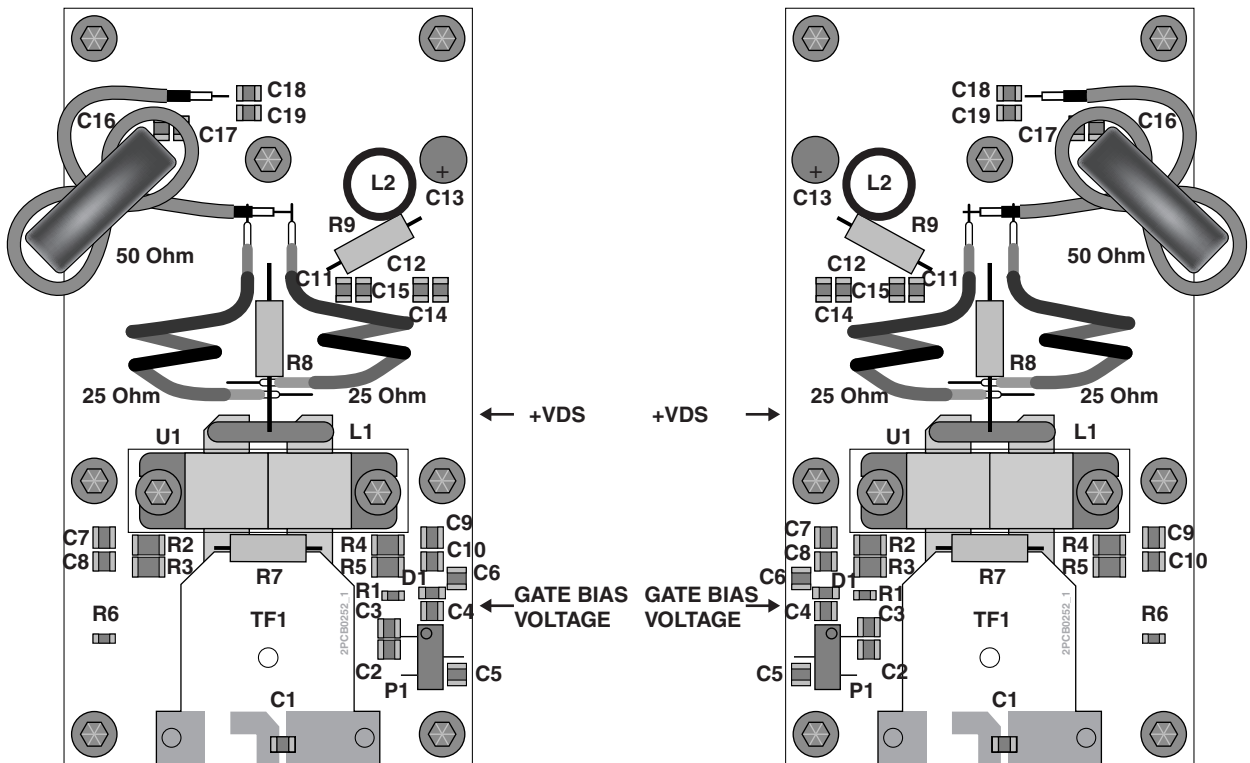

| | | | |
|---|----------------------------------|---|--|
| ELENOS | | Via G. Amendola 9 44028 Poggio Renatico (FE) Italy Tel +39 0532 829965 Fax +39 0532 829177 Website WWW.ELENOS.COM | |
| Title: POWER AMPLIFIER | | | |
| Board Code: E-ATG300-1.1 | Model: ETG250/300 | Rev 1.1 | |
| Proj. Engr. : A. Tomassini | Approved : A. Giovannelli | | |
| Date: Wednesday, November 15, 2000 | Sheet 1 | of 1 | |

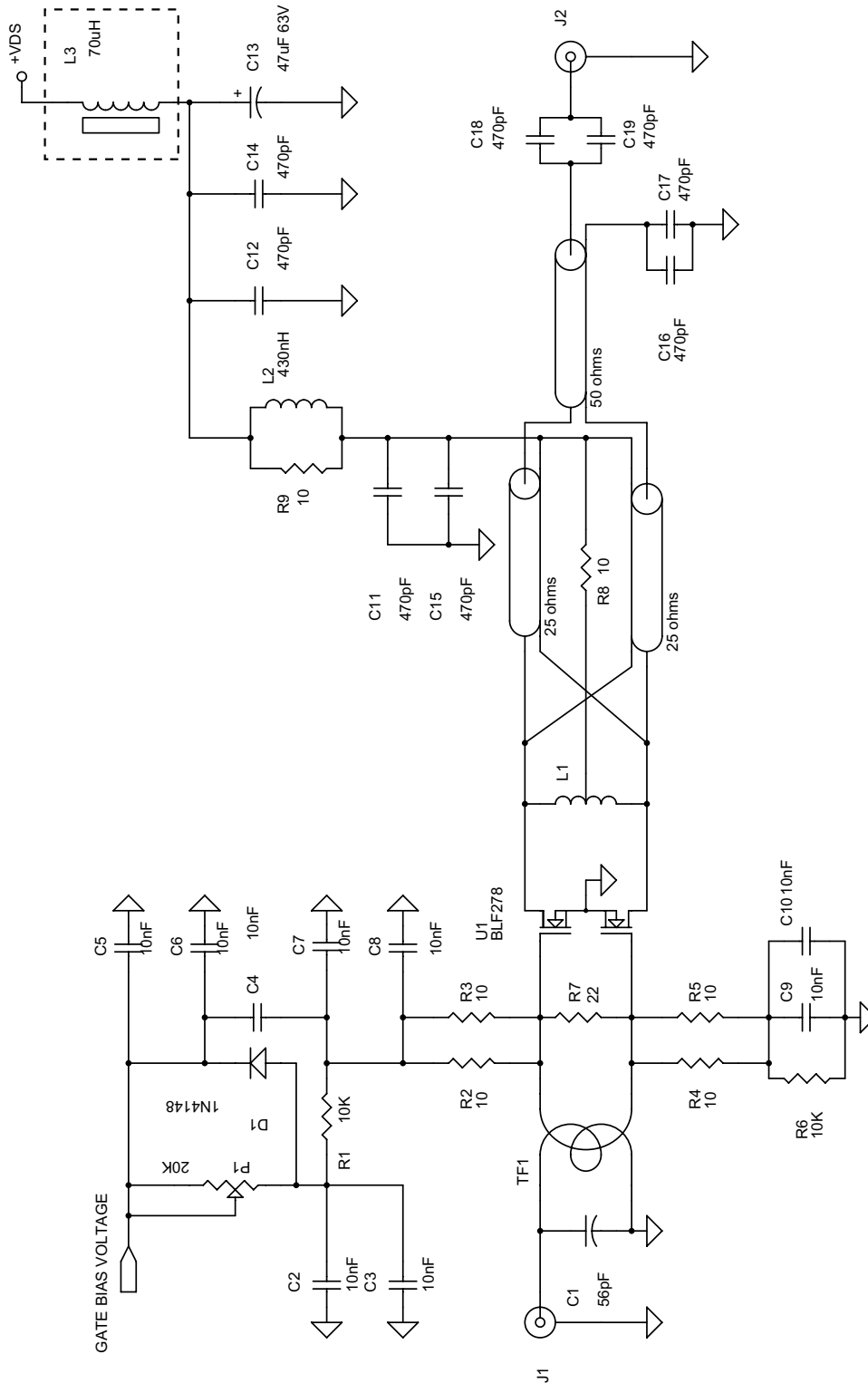

| | | | |
|------------------------------------|--------------------------|---|--|
| | | Via G.Amendola 9 44028 Poggio Renatico (FE) Italy | |
| | | Tel +39 0532 829965 Fax +39 0532 829177 | |
| | | Website WWW.ELENOS.COM | |
| Title: POWER AMPLIFIER | | | |
| Board Code: E-AT300-1.1 | Model: ETG250/300 | Rev 1.1 | |
| Proj. Engr. : A.Tomassini | Approved : A.Giovannelli | | |
| Date: Wednesday, November 15, 2000 | Sheet 1 of 1 | | |

Parts list

| Ref. | Description |
|------|-------------|
| C1 | 56pF |
| C2 | 10nF |
| C3 | 10nF |
| C4 | 10nF |
| C5 | 10nF |
| C6 | 10nF |
| C7 | 10nF |
| C8 | 10nF |
| C9 | 10nF |
| C10 | 10nF |
| C14 | 470pF |
| C11 | 470pF |
| C12 | 470pF |
| C15 | 470pF |
| C16 | 470pF |
| C17 | 470pF |
| C18 | 470pF |
| C19 | 470pF |
| C13 | 47uF 63V |
| D1 | 1N4148 |
| J1 | SMA CS VERT |
| J2 | BNC |
| L1 | IND |
| L2 | 430nH |
| L3 | 70uH |
| P1 | 20K |
| R6 | 10K |
| R1 | 10K |
| R2 | 10 |
| R3 | 10 |
| R4 | 10 |
| R5 | 10 |
| R8 | 10 |
| R9 | 10 |
| R7 | 22 |
| TF1 | |
| TF2 | 25 ohms |
| TF3 | 25 ohms |
| TF4 | 50 ohms |
| U1 | BLF278 |

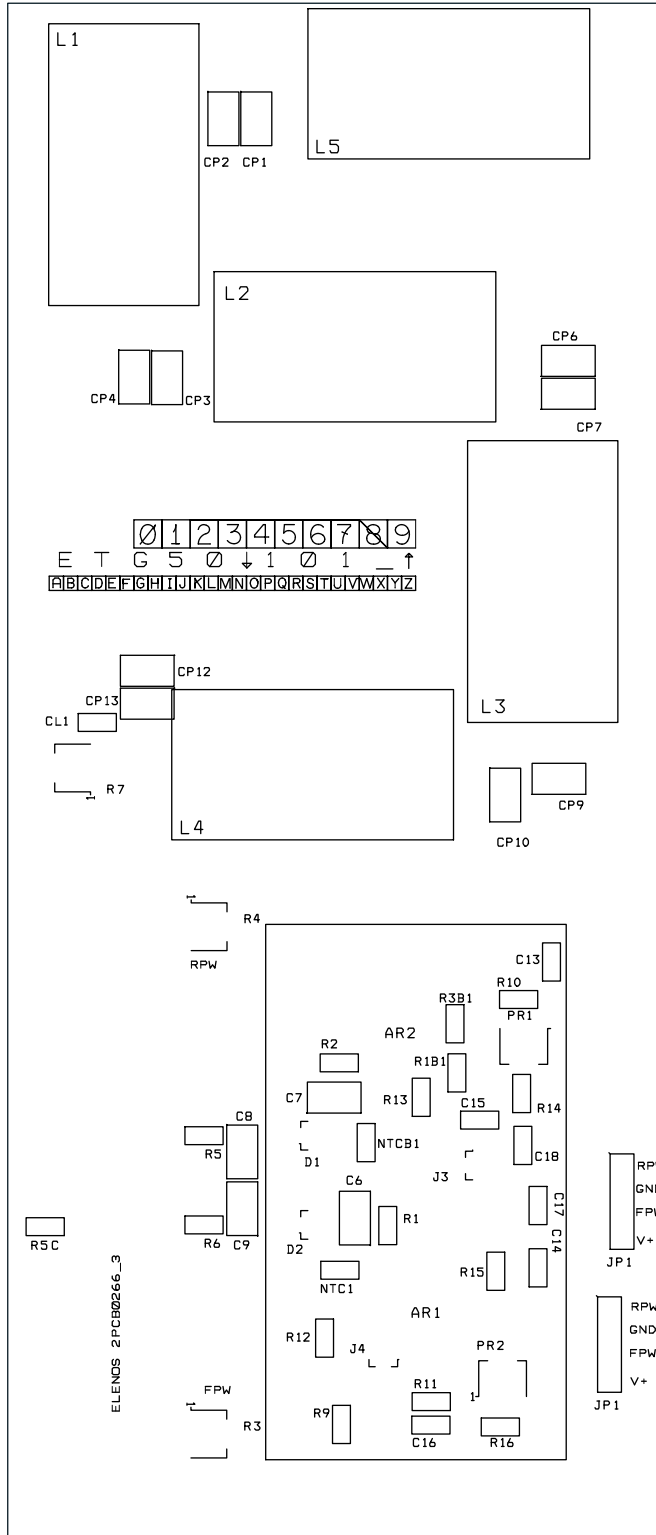

ELENOS Via G.Amendola 9 44028 Poggio Renatico (FE) Italy
Tel +39 0532 829965 Fax +39 0532 829177
Website WWW.ELENOS.COM

| | | |
|------------------------------------|--------------------------|-------|
| Title: LPF AND POWER PROBE | | |
| Board Code: 2PCB0266B | Model: ETG250-300 | Rev 1 |
| Proj. Engr. : A.Tomassini | Approved : A.Giovannelli | |
| Date: Wednesday, November 15, 2000 | Sheet 1 of 1 | |

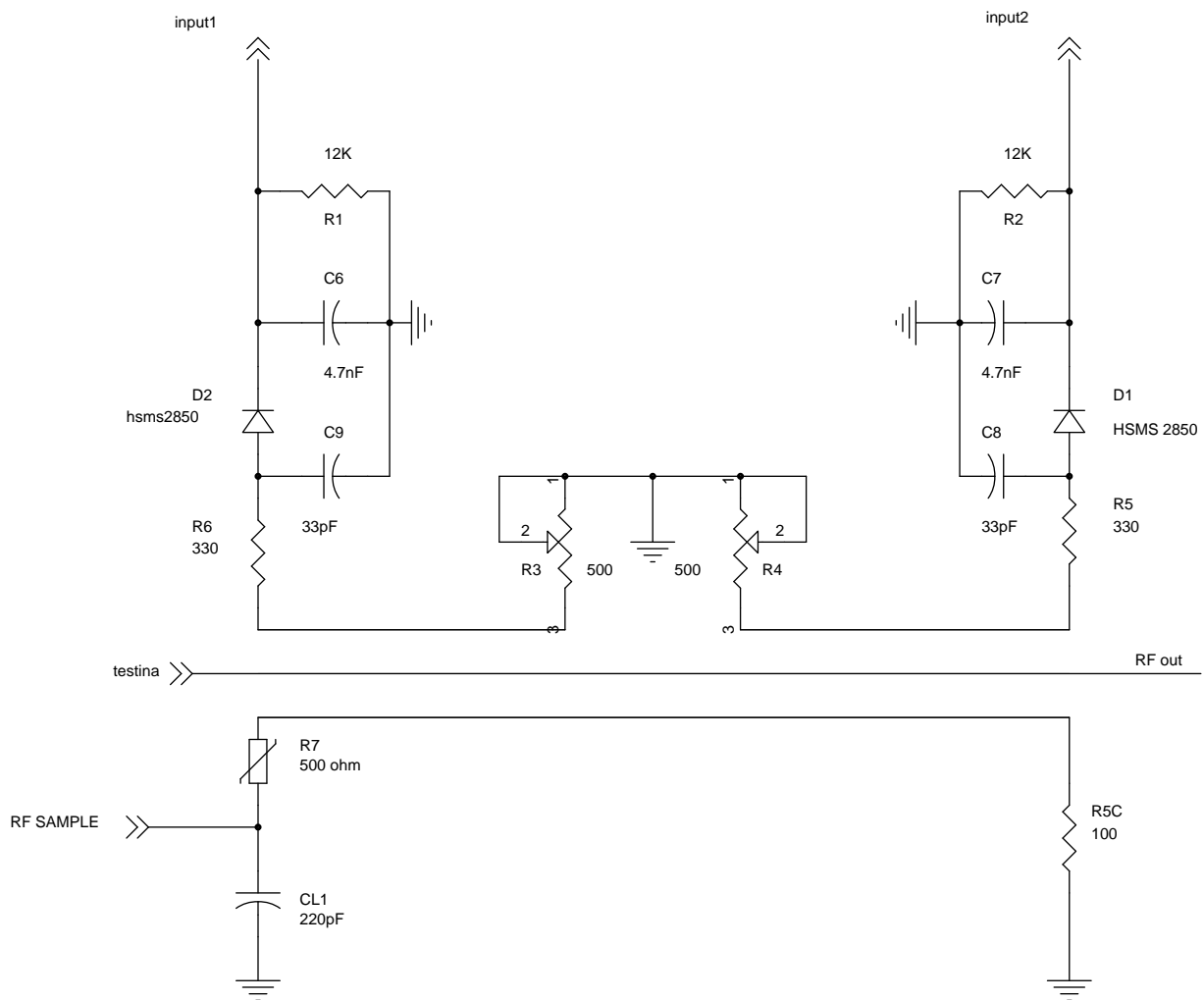

| | | | |
|------------------------------------|--------------------------|---|--|
| | | Via G.Amendola 9 44028 Poggio Renatico (FE) Italy | |
| | | Tel +39 0532 829965 Fax +39 0532 829177 Website WWW.ELENOS.COM | |
| Title: POWER PROBES | | | |
| Board Code: 2PCB0266B | Model: ETG250-300 | Rev 1 | |
| Proj. Engr. : A.Tomassini | Approved : A.Giovannelli | | |
| Date: Wednesday, November 15, 2000 | Sheet 1 of 3 | | |

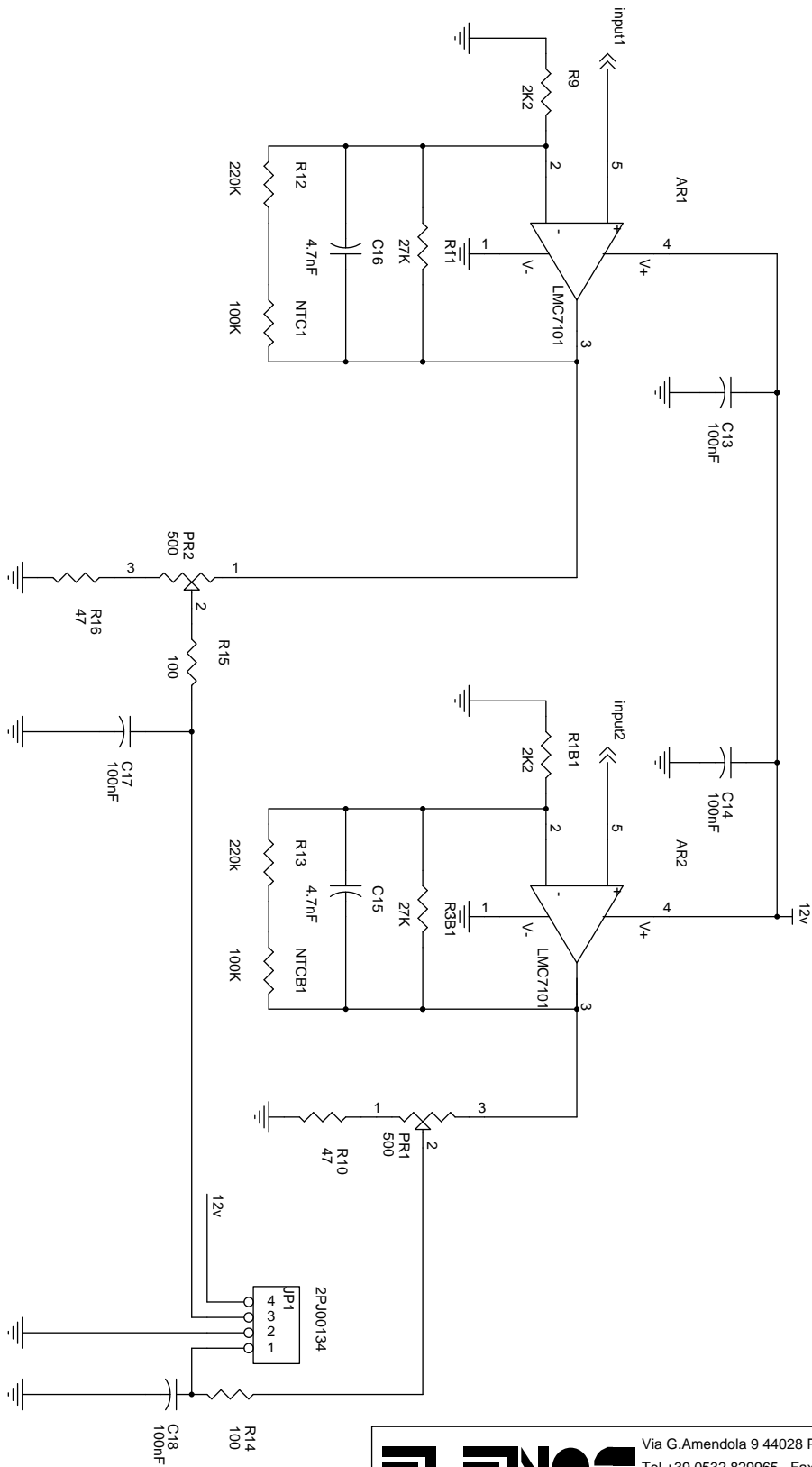

| | | |
|--|---------------------------------|--------------|
|  | | |
| Via G.Amendola 9 44028 Poggio Renatico (FE) Italy Tel +39 0532 829965 Fax +39 0532 829177 Website WWW.ELENOS.COM | | |
| Title: POWER PROBE AMPLIFIER | | |
| Board Code: 2PCB0266B | Model: ETG250-300 | Rev 1 |
| Proj. Engr. : A.Tomassini | Approved : A.Giovannelli | |
| Date: Wednesday, November 15, 2000 | Sheet 2 of 3 | |

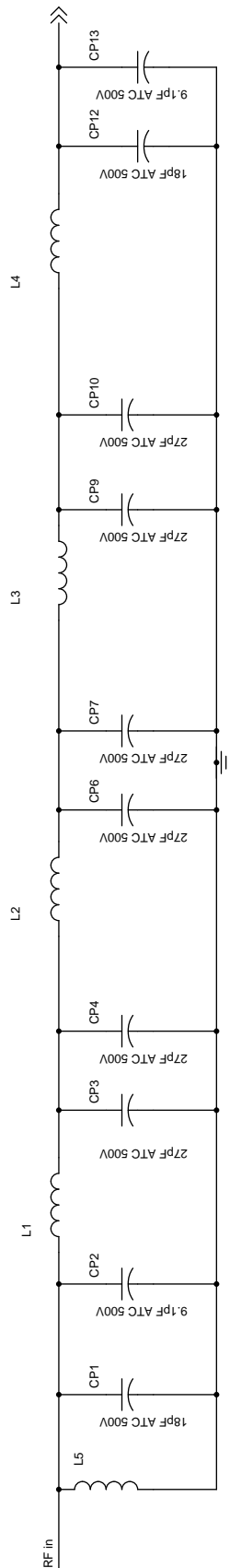

| | | | |
|------------------------------------|--------------------------|---|--|
| | | Via G.Amendola 9 44028 Poggio Renatico (FE) Italy | |
| | | Tel +39 0532 829965 Fax +39 0532 829177 Website WWW.ELENOS.COM | |
| Title: LPF | | | |
| Board Code: 2PCB0266B | Model: ETG250-300 | Rev 1 | |
| Proj. Engr. : A.Tomassini | Approved : A.Giovannelli | | |
| Date: Wednesday, November 15, 2000 | Sheet 3 of 3 | | |

Parts list

| Ref. | Description |
|-------|----------------|
| AR1 | LMC7101 |
| AR2 | LMC7101 |
| CL1 | 220pF |
| CP1 | 18pF ATC 500V |
| CP12 | 18pF ATC 500V |
| CP2 | 9.1pF ATC 500V |
| CP13 | 9.1pF ATC 500V |
| CP3 | 27pF ATC 500V |
| CP4 | 27pF ATC 500V |
| CP6 | 27pF ATC 500V |
| CP7 | 27pF ATC 500V |
| CP9 | 27pF ATC 500V |
| CP10 | 27pF ATC 500V |
| C6 | 4.7nF |
| C7 | 4.7nF |
| C15 | 4.7nF |
| C8 | 33pF |
| C9 | 33pF |
| C13 | 100nF |
| C14 | 100nF |
| C16 | 4.7nF |
| C17 | 100nF |
| C18 | 100nF |
| D1 | HSMS 2850 |
| D2 | hsms2850 |
| JP1 | 2PJ00134 |
| L1 | vedi note |
| L2 | vedi note |
| L3 | vedi note |
| L4 | vedi note |
| L5 | vedi note |
| NTC1 | 100K |
| NTCB1 | 100K |
| PR1 | 500 |
| PR2 | 500 |
| R3 | 500 |
| R4 | 500 |
| R1 | 12K |
| R2 | 12K |
| R5C | 100 |
| R6 | 330 |
| R5 | 330 |
| R7 | 500 ohm |
| R9 | 2K2 |
| R1B1 | 2K2 |
| R10 | 47 |
| R16 | 47 |
| R11 | 27K |
| R12 | 220K |
| R13 | 220k |
| R14 | 100 |
| R15 | 100 |
| R3B1 | 27K |

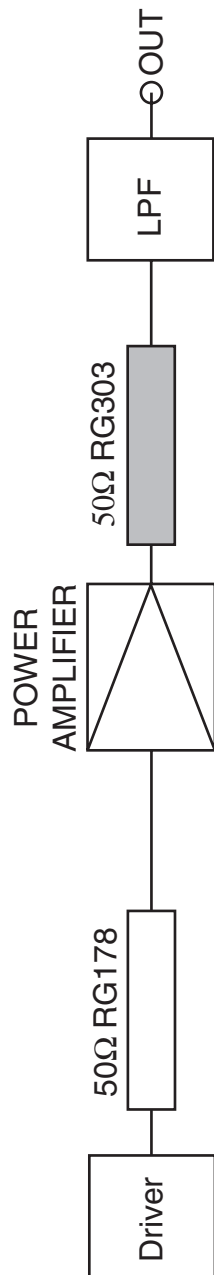

| | | |
|---|--------------------------|--------|
|  Via G.Amendola 9 44028 Poggio Renatico (FE) Italy Tel +39 0532 829965 Fax +39 0532 829177 Website WWW.ELENOS.COM | | |
| Title: SPLITTER INPUT AND COMBINER OUTPUT | | |
| Board Code: | Model: ETG250/300 | Rev 1 |
| Proj. Engr. : A.Tomassini | Approved : A.Giovannelli | |
| Date: Wednesday, November 15, 2000 | Sheet | 1 of 1 |

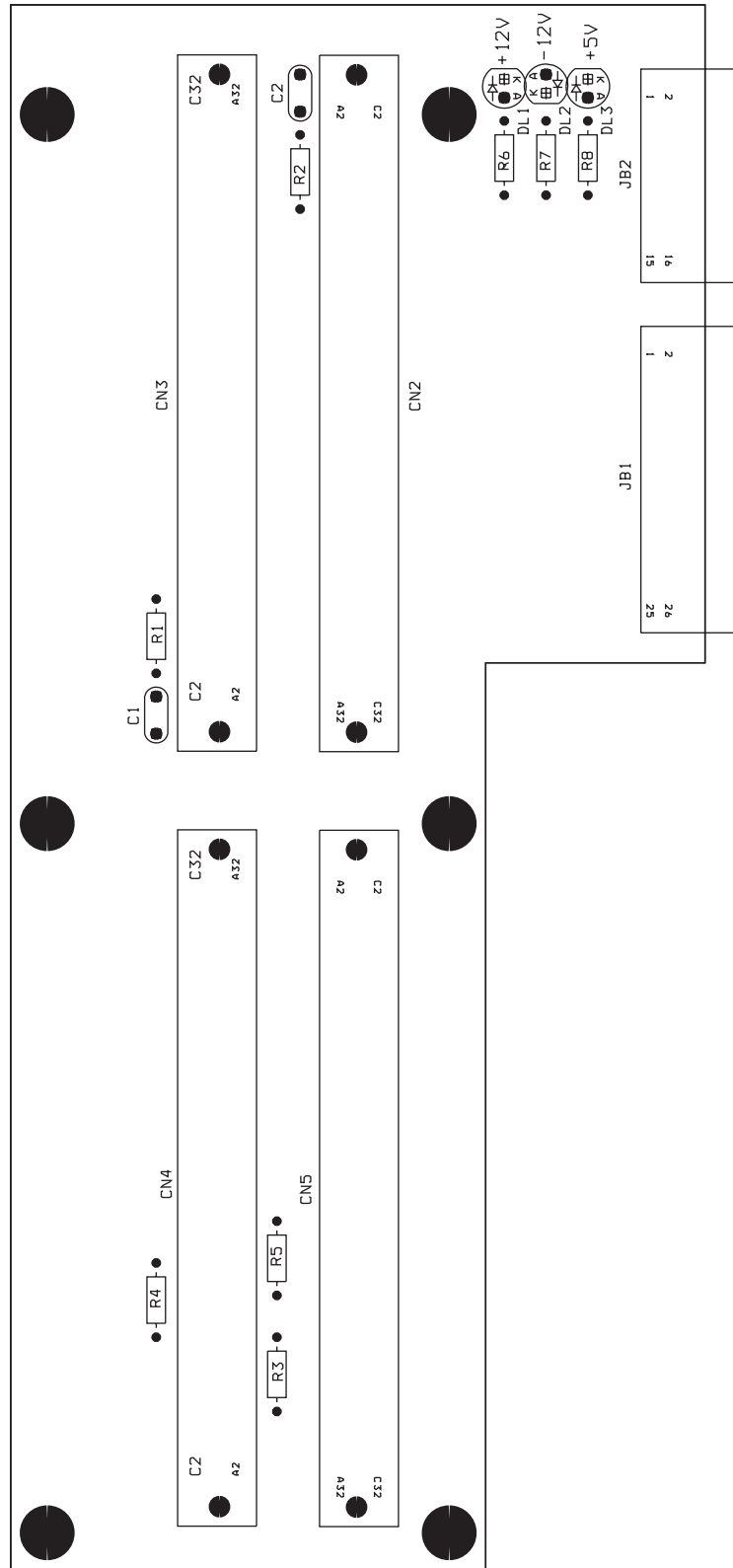

| | | |
|--|---------------------------------|-------------------|
|  | | |
| Via G.Amendola 9 44028 Poggio Renatico (FE) Italy Tel +39 0532 829965 Fax +39 0532 829177 Website WWW.ELENOS.COM | | |
| Title: BUS | | |
| Board Code: ETG500BU | Model: ETG250/300 | Rev 1.1 |
| Proj. Engr. : A.Tomassini | Approved : A.Giovannelli | |
| Date: Wednesday, November 15, 2000 | Sheet 1 of 1 | |

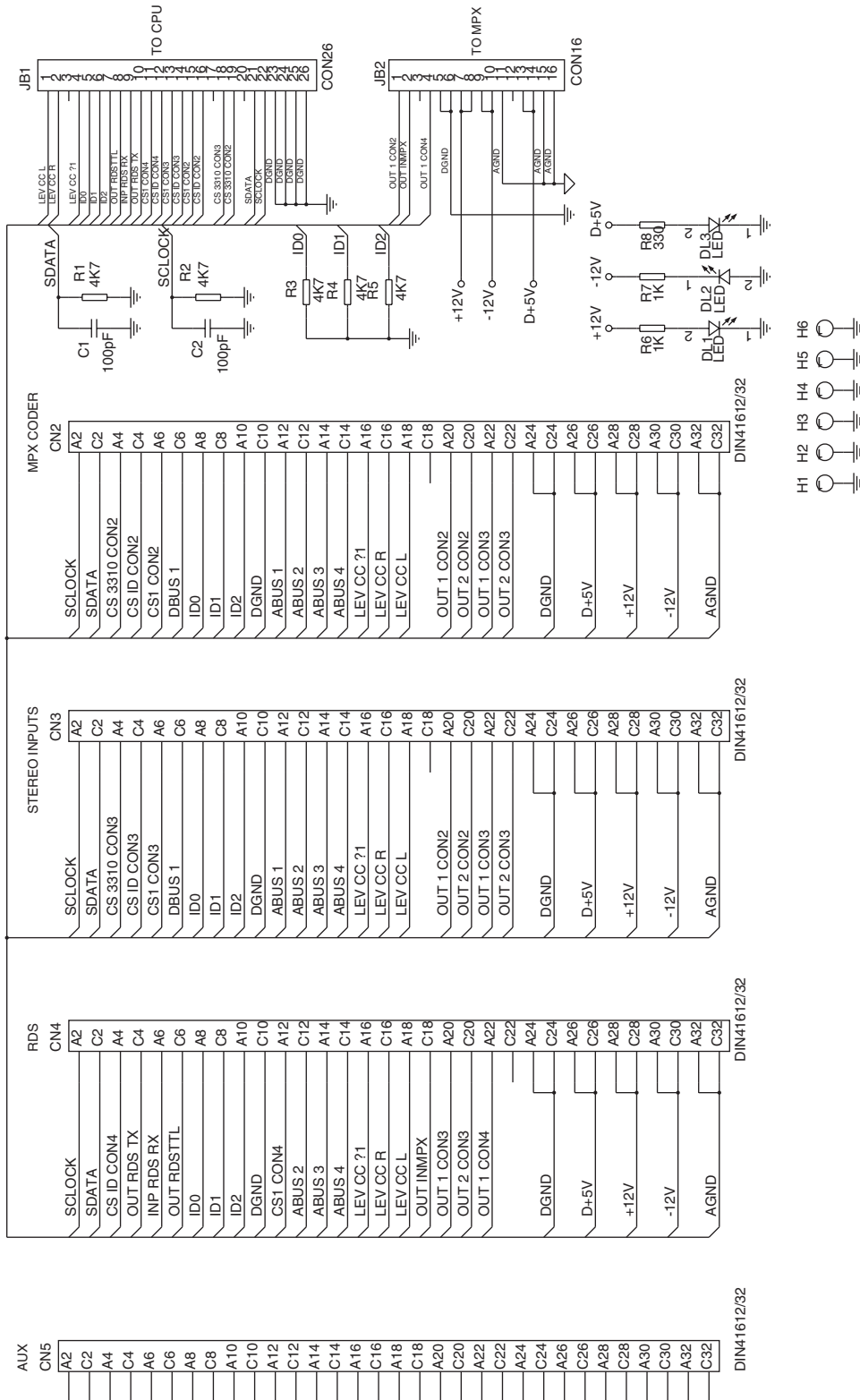

| | | | |
|---|----------------------------|---|--|
| | | Via G. Amendola 9 44028 Poggio Renatico (FE) Italy Tel +39 0532 829965 Fax +39 0532 829177 Website WWW.ELENOS.COM | |
| Title: BUS | | | |
| Board Code: ETG500BU | Model: ETG250/300 | Rev 1.1 | |
| Proj. Engr. : A. Tomassini | | Approved : A. Giovannelli | |
| Date: Wednesday, November 15, 2000 | Sheet 1 of 1 | | |

Parts list

| Ref. | Description |
|------|-------------|
| CN2 | DIN41612/32 |
| CN3 | DIN41612/32 |
| CN4 | DIN41612/32 |
| CN5 | DIN41612/32 |
| C2 | 100pF |
| C1 | 100pF |
| DL1 | LED |
| DL2 | LED |
| DL3 | LED |
| H1 | CON1 |
| H2 | CON1 |
| H3 | CON1 |
| H4 | CON1 |
| H5 | CON1 |
| H6 | CON1 |
| JB1 | CON26 |
| JB2 | CON16 |
| R1 | 4K7 |
| R2 | 4K7 |
| R3 | 4K7 |
| R4 | 4K7 |
| R5 | 4K7 |
| R6 | 1K |
| R7 | 1K |
| R8 | 330 |

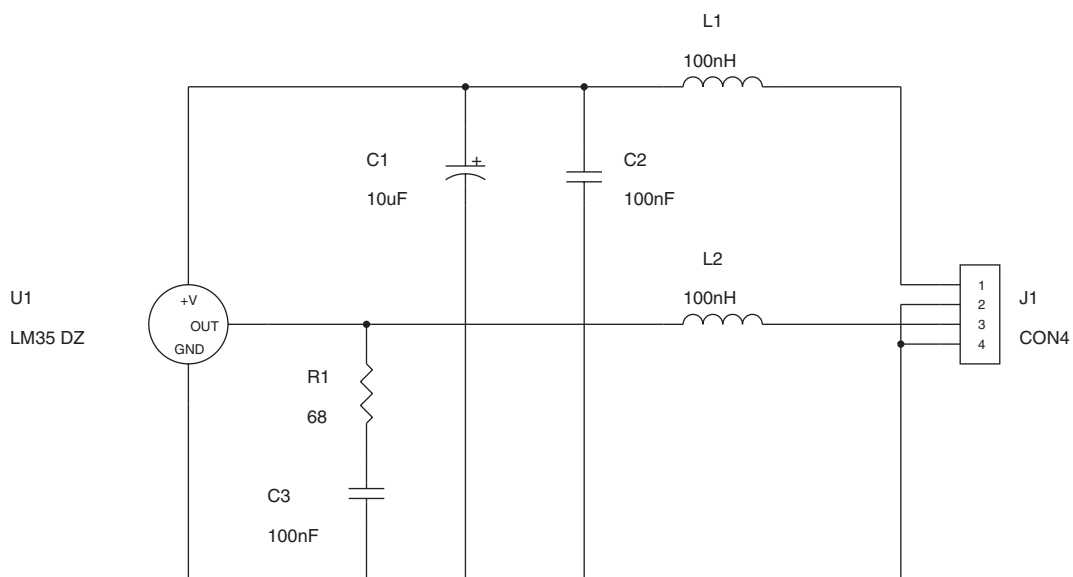
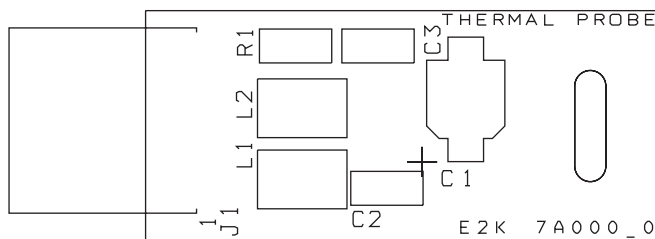

| | | | |
|--|------------------------------|---|---------------|
|  | | Via G.Amendola 9 44028 Poggio Renatico (FE) Italy | |
| | | Tel +39 0532 829965 Fax +39 0532 829177 Website WWW.ELENOS.COM | |
| Title: THERMAL PROBE | | | |
| Board Code: | E2K 7A000_0 | Model: | ETG250-300 |
| Proj. Engr. : | A.Tomassini | Approved : | A.Giovannelli |
| Date: | Wednesday, November 15, 2000 | Sheet | 1 of 1 |
| | | | Rev 0 |

Parts list

| Ref. | Description |
|------|-------------|
| C1 | 10uF |
| C3 | 100nF |
| C2 | 100nF |
| J1 | CON4 |
| L2 | 100nH |
| L1 | 100nH |
| R1 | 68 |
| U1 | LM35 DZ |

TROUBLESHOOTING GUIDE

| Problem | Cause | Solution |
|--|---|---|
| <ul style="list-style-type: none"> ✓ The unit will not power up | <ul style="list-style-type: none"> ✓ Power cable missing or faulty ✓ Power supply fuses (rear panel) blown ✓ Auxiliary power supply faulty ("MAIN" front panel led not lit) | <ul style="list-style-type: none"> ✓ Connect or replace power cable and try again ✓ Replace the fuses and try again ✓ Contact the manufacturer |
| <ul style="list-style-type: none"> ✓ The unit does not reach required power level | <ul style="list-style-type: none"> ✓ Unit in Stand-By ✓ Antenna or amplifier not connected ✓ PLL unlocked ("ON Air" front panel indicator not lit) ✓ Power supply or RF module faulty | <ul style="list-style-type: none"> ✓ Access the RF menu and enable "RF On" ✓ Connect the antenna or amplifier (check the integrity of the connection) ✓ Contact the manufacturer ✓ Contact the manufacturer |
| <ul style="list-style-type: none"> ✓ The unit transmits on the wrong frequency | <ul style="list-style-type: none"> ✓ PLL board faulty | <ul style="list-style-type: none"> ✓ Contact the manufacturer |
| <ul style="list-style-type: none"> ✓ Absence of modulation on the output and on the display | <ul style="list-style-type: none"> ✓ Missing or faulty audio cable ✓ MPX board faulty ✓ Modulation switched off | <ul style="list-style-type: none"> ✓ Connect or replace the audio cable ✓ Contact the manufacturer ✓ Enable modulation from the audio menu |
| <ul style="list-style-type: none"> ✓ Absence of modulation on the output but not on the display | <ul style="list-style-type: none"> ✓ MPX board faulty | <ul style="list-style-type: none"> ✓ Contact the manufacturer |
| <ul style="list-style-type: none"> ✓ Modulation does not reach the required value | <ul style="list-style-type: none"> ✓ Low audio input level ✓ MPX board faulty ✓ ALC threshold programming error | <ul style="list-style-type: none"> ✓ Increase the audio input level ✓ Contact the manufacturer ✓ Set the correct threshold |
| <ul style="list-style-type: none"> ✓ Absence of stereo modulation | <ul style="list-style-type: none"> ✓ Stereo carrier disabled ✓ Missing or damaged audio cable ✓ Stereo board faulty ✓ Missing stereo board and/or stereo encoder | <ul style="list-style-type: none"> ✓ Enable stereo carrier from the user setup menu ✓ Connect or replace the audio cable ✓ Contact the manufacturer ✓ Insert stereo board and/or stereo encoder |
| <ul style="list-style-type: none"> ✓ Absence of RDS transmission | <ul style="list-style-type: none"> ✓ RDS switched off ✓ RDS message programming error ✓ RDS board missing | <ul style="list-style-type: none"> ✓ Switch on RDS from the user setup menu ✓ Reprogram RDS board ✓ Insert RDS board |

| Parameter | Values |
|-----------------------------|---|
| FREQUENCY BAND | 87.5 - 108.0 MHz in steps of 10KHz |
| OUTPUT POWER | 0 - 250 (300) Watt continuously adjustable |
| OUTPUT POWER STABILITY | between +/- 0.1 dB |
| FINAL STAGE TECHNOLOGY | MOSFET |
| OUTPUT IMPEDANCE | 50 Ohm |
| OUTPUT CONNECTOR | Standard type "N" Female |
| HARMONIC SUPPRESSION | > 70 dB |
| SPURIOUS SIGNAL SUPPRESSION | > 80 dB |
| FREQUENCY STABILITY | Better than 1 ppm: (0 - +40°C) in the first year |
| TYPE OF MODULATION | F3 Direct FM Modulation on RF oscillator at fundamental frequency |
| RESIDUAL AM | Asynchronous: 0.1% Synchronous: 0.2% (typical values) |

Low frequency section

| Parameter | Values |
|--|---|
| V.S.W.R. PROTECTION | Progressively reduced to a safety level (50W) |
| AUTOMATIC GAIN CONTROL | Stabilises the output power to the level programmed |
| INTERMODULATION DISTORTION | <0.05% measured with composite tones 1KHz and 1.3KHz, 1:1 ratio at 100% modulation |
| FREQUENCY DEVIATION | +/- 75KHz adjustable in steps of 0.1dB |
| THD+N | <0.03% @ 1 KHz |
| FM S/N RATIO with weighted CCIR filter | -72dB ref. at +/-75KHz dev. |
| PRE-EMPHASIS | 50/75 us +/-0.1dB |
| FREQUENCY RESPONSE | Mono: +/-0.15dB (30Hz - 15KHz) MPX: +/-0.1dB (30Hz - 100KHz) -45dB at 19KHz Stereo: +/-0.15dB (30Hz - 15KHz) SCA1,2,3: +/-1 dB (20KHz - 100KHz) -45dB at 19KHz |
| STEREO SEPARATION | 65dB @ 1KHz typical value |
| PILOT TONE | Frequency: 19KHz +/- 1Hz deviation 7.5KHz adjustable |
| INPUT MODULE AUDIO L/R | Input Impedance: 10KOhm - 600Ohm (selectable) balanced i/p Frequency response: 20Hz - 15KHz Adjustment: -12 - +12dB in steps of 0.1 dB Connector: XLR female |
| ATTENUATION AT 19KHz | 45dB |
| MPX INPUT MODULE | Impedance 10KOhm unbalanced i/p Frequency response: 30Hz - 100KHz Adjustment: -12 - +12dB in steps of 0.1 dB Connector: BNC female |
| SCA INPUT | Impedance 10KOhm unbalanced i/p Frequency response: 20KHz - 100KHz Connector: BNC female |

General characteristics

| Parameter | Value |
|--------------------|--|
| AMBIENT CONDITIONS | Temperature: (operating): 0- +45°C (non operating): -20 - +50°C Humidity (operating): 95% at 40°C (non operating): 90% at 65°C Altitude: (operating): >4600 metres (non operating): > 15000 metres |

| Parameter | Value |
|-------------------|--|
| WEIGHT | 20Kg switch-mode version 30Kg transformer version |
| DIMENSIONS | 50x14x50 cm |
| POWER SUPPLY | 110-240V |
| POWER CONSUMPTION | 400W typical at maximum power output ETG250 500W typical at maximum power output ETG300 |
| COOLING | Forced ventilation |

Limitations on cable lengths

| | |
|--------------------|---------------------------------|
| RS232 | connection cable less than 1 m. |
| MPX | connection cable less than 1 m. |
| SCA1 | connection cable less than 1 m. |
| SCA2 | connection cable less than 1 m. |
| Power supply cable | length less than 3 m. |



BROADCAST EQUIPMENT COMPANY

Via G. Amendola 9 - 44028 Poggio Renatico (FE) - Italy
Tel. +39 0532 829 965 - Fax +39 0532 829 177
E-Mail: info@elenos.com
Internet address: www.elenos.com